







ILS - ORGANIC RESPONSE Sensor Node



App
"Organic Response Express"
app (Bluetooth)









App
"Organic Response Express"
app (Bluetooth)



<https://qrco.de/bcsGF9>





Organic Response GATEWAY
art. X685

MANUAL USE









App
"Organic Response"
(Infrared with Dongle, for cloud
solution/istallation with gateway)



Dongle
art. X687



I.R.





App
"Organic response Express"



<https://qrco.de/bcsGCA>

OVERVIEW

Sensor Nodes and their communications form the foundation of the Distributed Intelligence which lies at the heart of the Organic Response System. Each Sensor Node has a motion detector, ambient light sensor, infrared transceiver and an RF transceiver. Ideally (and typically) Sensor Nodes are integrated into each luminaire.

Sensor Nodes control the light output of their associated luminaire using a DALI two wire connection to the Luminaire Driver. Light output is based on a combination of information the Sensor Node collects from its environment, and information it receives from neighboring Sensor Nodes, Wall Switches, smartphones or other devices connected via the OR IoT Gateway. Sensor Nodes have numerous configurable parameters, including, but not limited to:

- Max Light Level
- Personality
- Dwell Time
- Daylight Dimming
- Scenes
- Zones

Further information on the configuration and use of these parameters can be found in the Organic Response user guide at iguzzini.com or directly contact iGuzzini.

TECHNICAL DATA

DIMMING	Logarithmic. Note: The DALI driver must be configured for logarithmic dimming function.
NODE TO NODE COMMUNICATION PROTOCOL - CONTROL	Organic Response - Wireless infrared
NODE TO NODE COMMUNICATION PROTOCOL - DATA	Wirepas – Wireless RF
RF FREQUENCY BAND	2.4 GHz
RF RANGE - NODE TO NODE	8m max – non Line Of Sight (wireless link operating mode)
RF OPERATIONAL PERFORMANCE	Ability to operate in an office environment with performance unaffected by surrounding structures, walls, ceilings, enclosures and by other RF devices which may be present.
PRODUCT ENVIRONMENT FOR USE	Indoor areas, with recommended ceiling height from 2.7m to 3.7m

MOTION SENSOR

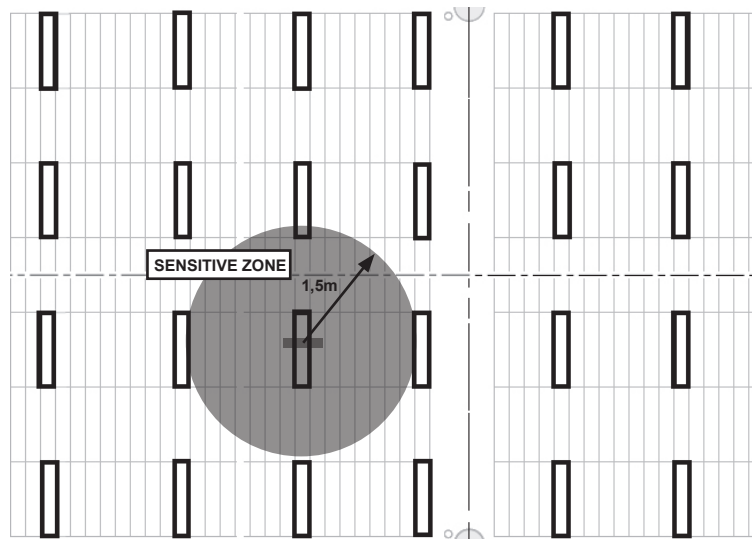

Detection Range of a single Sensor Node imposed over a Typical Office Layout.
(1.5m circular radius, 2.7m luminaire height)

KEEPING THE OIC CONTIGUOUS

Organic Response Sensor Nodes communicate with each other wirelessly to form a smart sensor network which we call the Occupancy Information Cloud (OIC)™. The system relies on peer to peer communication between neighboring Sensor Nodes to maintain the integrity of the OIC and allow the light fittings to operate as a system. For this reason, nodes must be installed with the spacing indicated below:

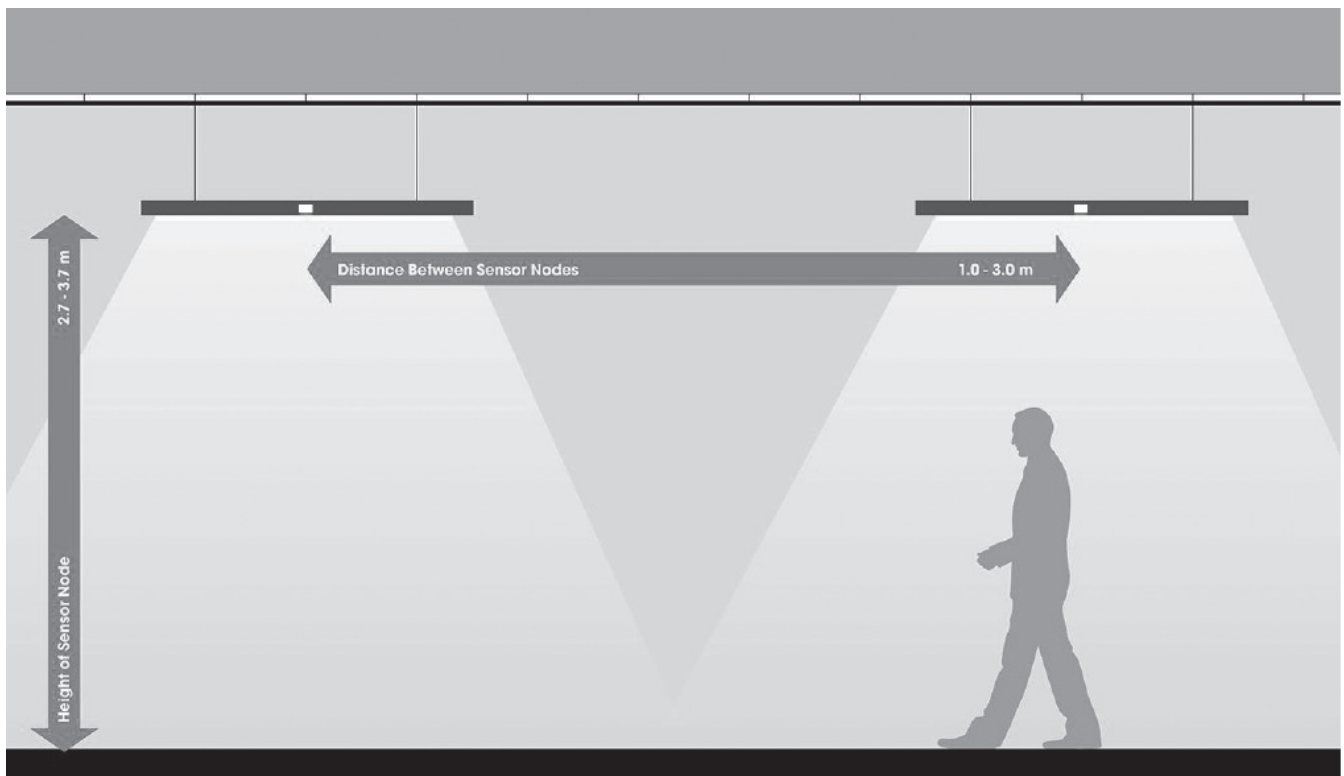

Recommended mounting height and neighbour spacing.
For height - spacing other than those indicated, please contact iGuzzini.

Organic Response GATEWAY
art. X685

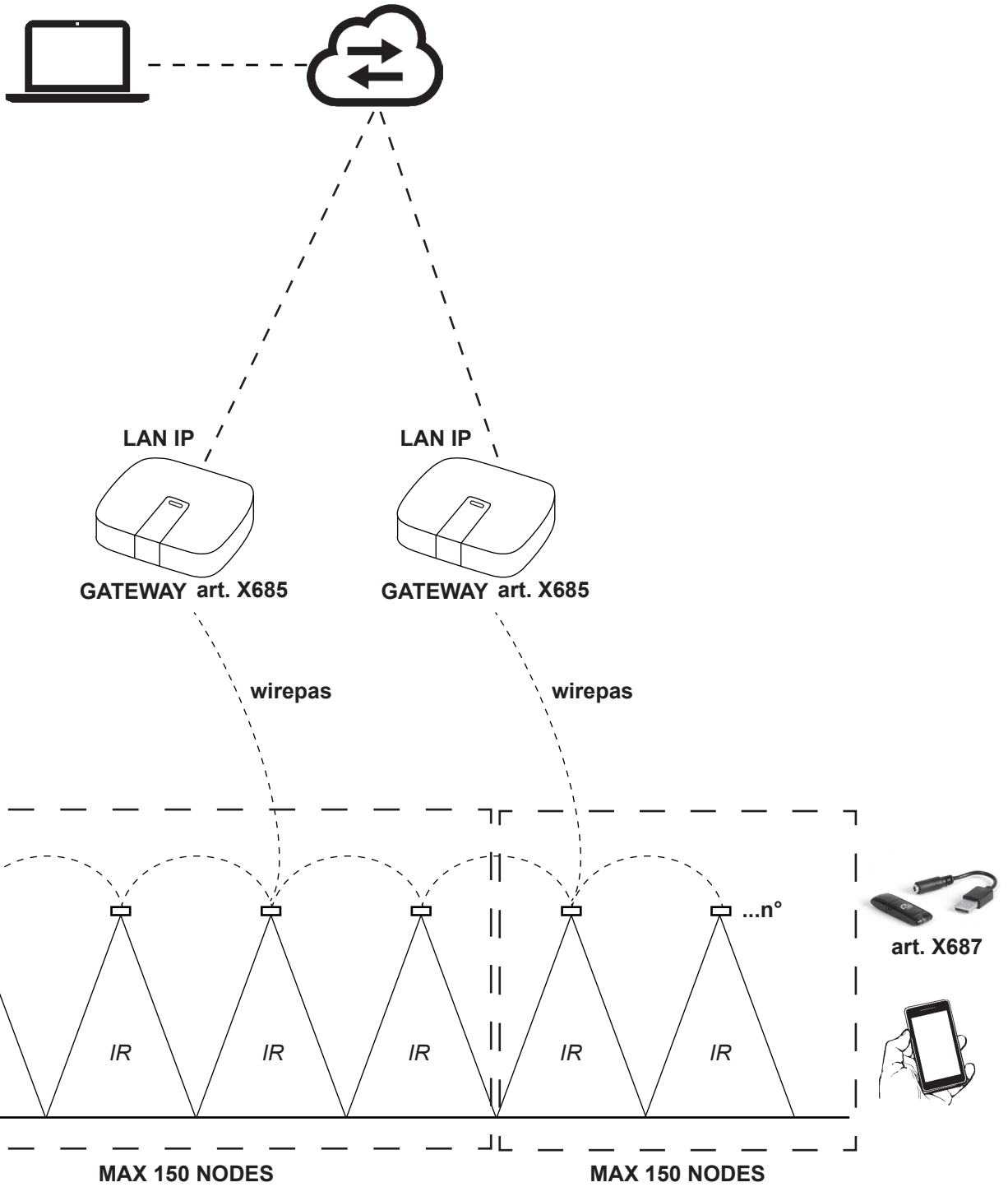

SPACEPAD

(CASAMBI)

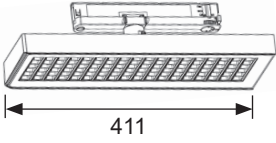

(DALI-2)

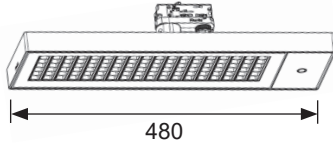

(DALI)

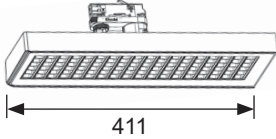

(ORGANIC RESPONSE)

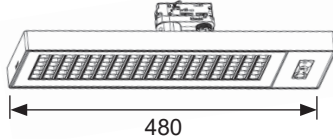

IT Attenzione:

La sicurezza dell'apparecchio e' garantita solo con l'uso appropriato delle seguenti istruzioni; pertanto e' necessario conservarle.

EN Warning:

The safety of this fixture is guaranteed only if you comply with these instructions; remember to conserve in a safe place.

FR Attention:

La sécurité de l'appareil n'est garantie qu'en cas d'utilisation correcte des instructions suivantes; il faut par conséquent les conserver.

DE Achtung:

Die sicherheit des gerätes wird nur durch sachgemässe befolgung nachstehender anweisungen gewährleistet; ihre aufbewahrung ist deshalb sehr wichtig.

NL Opgelet:

De veiligheids van dit toestel is slechts dan gegarandeerd als indien de volgende instructies strikt worden toegepast; daarom moet men ze ook bewaren.

ES Atencion:

La seguridad del aparato se garantiza solo cumpliendo cuidadosamente las siguientes instrucciones; por ello, es necesario conservarlas.

DA Bemærk:

Sikkerheden ved brug af armaturet kan kun garanteres, hvis disse anvisninger følges; sørg derfor for at gemme dem.

NO Advarsel:

Sikkerheten til dette apparatet garanteres kun hvis du overholder disse instruksjonene; husk å oppbevare dem på et trygt sted.

SV Observera:

Utrustningens säkerhet kan endast garanteras om dessa anvisningar respekteras i detalj. Spara därför dessa anvisningar för framtida konsultation.

RU Внимание:

Мы гарантируем безопасную эксплуатацию изделия только при соблюдении следующих инструкций; с этой целью необходимо сохранить данную брошюру.

ZH 警告:

为确保该装置安全, 请遵守操作指示; 并于安全场所放置。

تحذير:

لا يمكن ضمان سلامة هذا الجهاز إلا إذا التزمت بهذه التعليمات. يجب حفظها في مكان آمن.

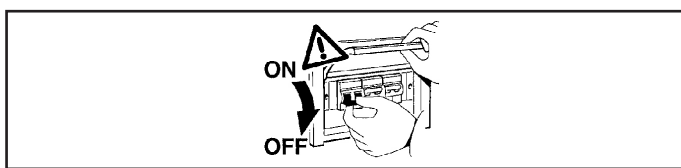

IT N.B.: Durante l'installazione del sistema rispettare scrupolosamente le norme impiantistiche vigenti.

EN N.B.: When installing the system, strictly comply with all regulations on installation in force.

FR N.B.: Lors de l'installation du système veuillez respecter rigoureusement les normes en vigueur en la matière.

DE N.B.: Beachten sie bei der installation des systems gewissenhaft die gültigen bestimmungen bezüglich der anlagentechnik.

NL N.B.: Bij het installeren van het systeem moet u de geldende installatienormen strikt naleven.

ES N.B.: Durante la instalación del sistema respetar e scrupulosamente las normas de instalación vigentes.

DA N.B.: Under installation af systemet skal man nøje overholde de gældende regler for disse anlæg.

NO N.B.: Ved installasjon av systemet skal alle forskrifter om installasjon som gjelder følges strengt.

SV OBS.: Under installationen av systemet ska installationsföreskrifterna respekteras i detalj.

RU примечание: в процессе монтажа системы строго соблюдайте национальные действующие нормативы по электропроводке.

ZH 注意: 在安装系统时请遵守设备的安装规定。

AR ملاحظة: أثناء تركيب النظام يجب التقيد بحرص بالنظم الساندة المتعلقة بالشبكة الكهربائية.

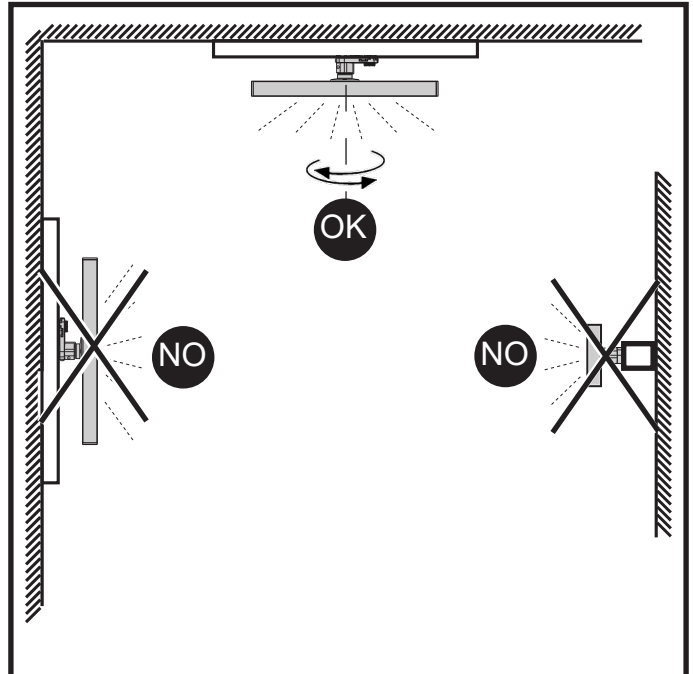
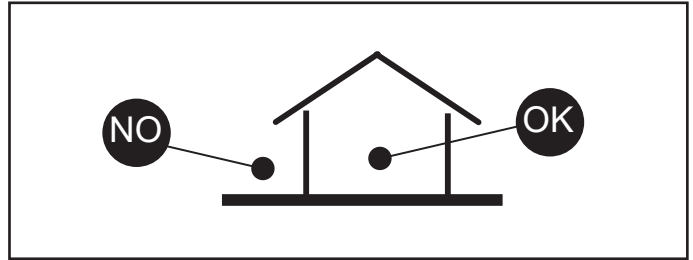

IT Per le posizioni di installazione, attenersi a quelle illustrate, eventualmente contattare la iGuzzini.

EN All installation positions must comply with those illustrated. In the event of any doubt, contact iGuzzini.

FR Pour les positions d'installation, se conformer aux positions illustrées; contacter la société iGuzzini en cas de nécessité.

DE Für die Einbaupositionen die Abbildungen beachten. Eventuell iGuzzini kontaktieren.

NL Houd u voor de installatieposities aan degene die zijn weergegeven. Neem eventueel contact op met iGuzzini.

ES Respetar las posiciones de instalación ilustradas y, en caso de duda, contactar con iGuzzini.

DA For installationspositioner skal man holde sig til de viste, og eventuelt kontakte iGuzzini.

NO For installasjonsplasseringene henviser vi til illustrasjonene, eller ta eventuelt kontakt med iGuzzini.

SV Följ de angivna positionerna för installationen. Kontakta vid behov iGuzzini.

RU При выборе положения для монтажа следует обратиться к проиллюстрированному либо обратиться в компанию iGuzzini.

ZH 安装位置请参考图示, 必要时也可联系iGuzzini.

AR في ما يتعلق بأوضاع التركيب، التزم بما هو موضح ومحدّد، إذا دعت الضرورة اتصل ب iGuzzini

IT Il funzionamento dei prodotti è garantito solo con l'utilizzo di binari ed accessori iGuzzini

EN Correct product operation is only guaranteed if iGuzzini tracks and accessories are used.

FR Le fonctionnement des produits n'est garanti qu'en cas d'utilisation de rails et accessoires iGuzzini

DE Die Funktion der Produkte ist nur mit dem Einsatz von Schienen und Zubehör iGuzzini gewährleistet

NL De werking van de producten wordt alleen gegarandeerd bij het gebruik van iGuzzini rails en accessoires.

ES El funcionamiento de los productos se garantiza solamente si se utilizan railes y accesorios iGuzzini.

DA Produktet er kun garanteret med brug af iGuzzini-skiner og -udstyr.

NO Produktenes korrekte drift garanteres bare ved bruk av spor og tilbehør fra iGuzzini

SV Produkternas funktion garanteras endast vid användning av spår och tillbehör från iGuzzini

RU Функционирование продуктов гарантировано только при использовании бинариев и аксессуаров iGuzzini

ZH 此产品的正常运行只有在使用IGUZZINI的轨道及配件的情况下才可以保证

AR يضمن عمل المنتجات فقط من خلال استعمال سكة ومعدات من نوع iGuzzini

DALI VERSION

NO

BEFORE 2016

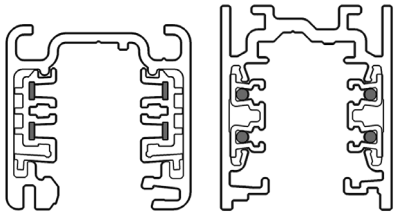

OK

AFTER 2016

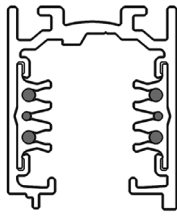

IT Per chiarimenti contattare la "iGuzzini".

EN For more details contact "iGuzzini".

FR Pour plus d'informations contacter « iGuzzini ».

DE Pour plus d'informations contacter « iGuzzini ».

NL Neem contact op met "iGuzzini" voor meer informatie.

ES Para más información contactar con "iGuzzini".

DA Kontakt "iGuzzini" for evt. Afklaringer.

NO Ta kontakt med "iGuzzini" for forklaring.

SV Kontakta "iGuzzini" vid eventuella oklarheter.

RU За разъяснениями обращаться в компанию "iGuzzini".

ZH 如需进一步信息请联系 "iGuzzini"。

AR

للتوضيح اتصل ب "iGuzzini"

Version:

- DALI

- DALI-2

- ORGANIC RESPONSE

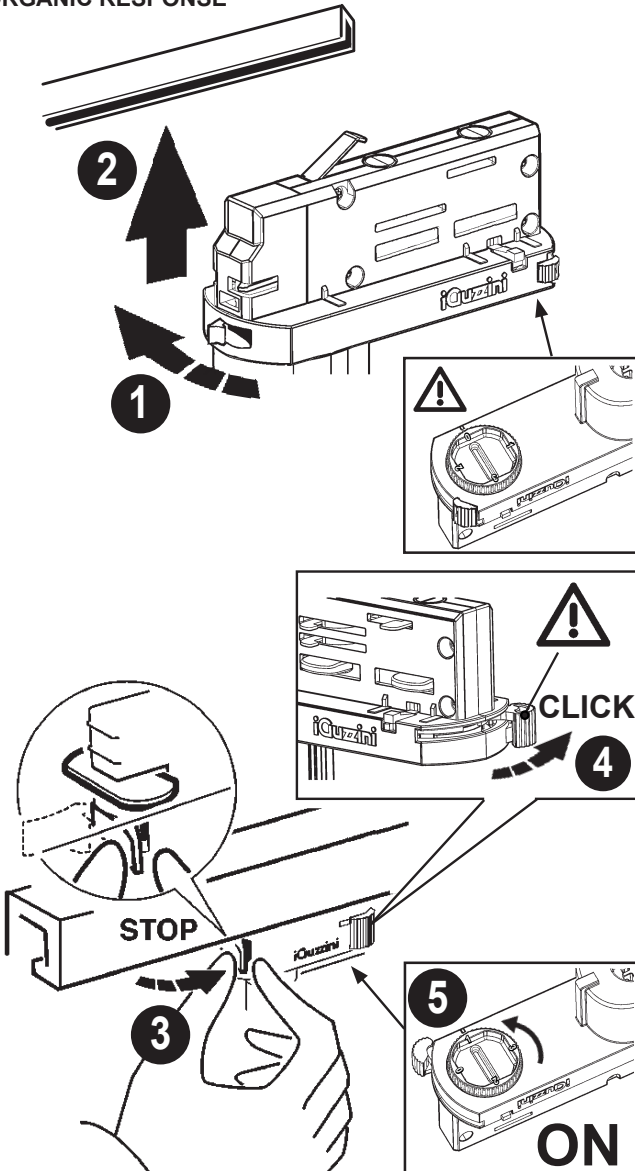

Version:

- CASAMBI

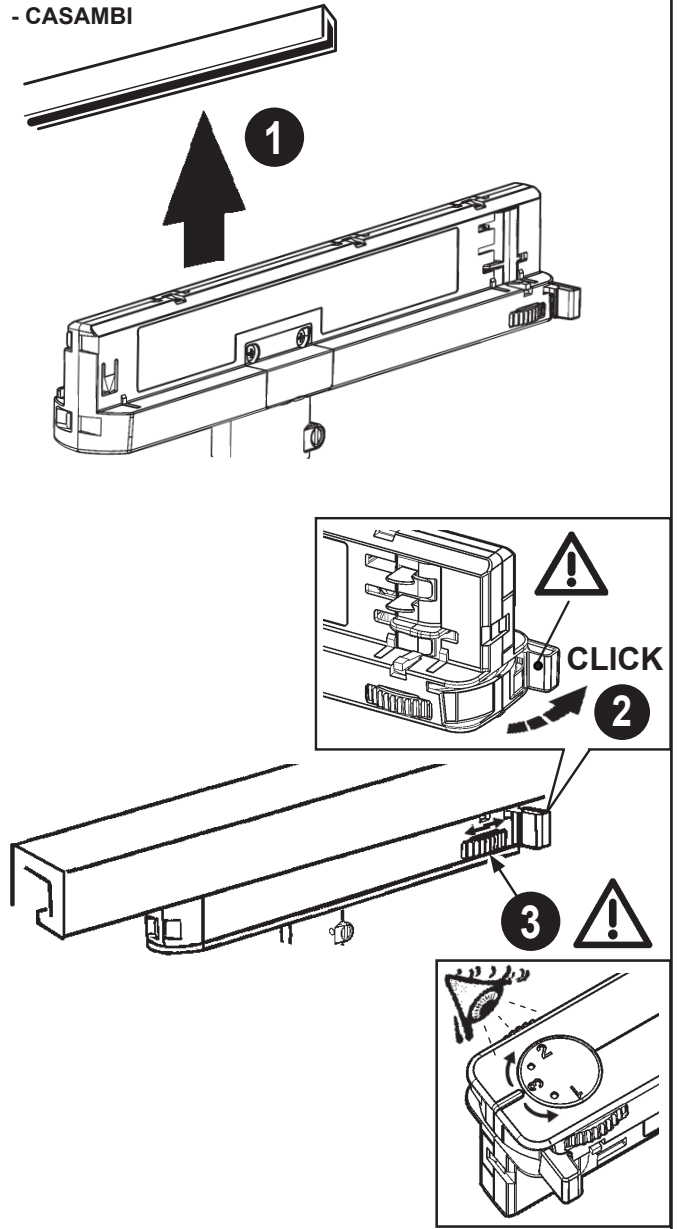

DISASSEMBLY

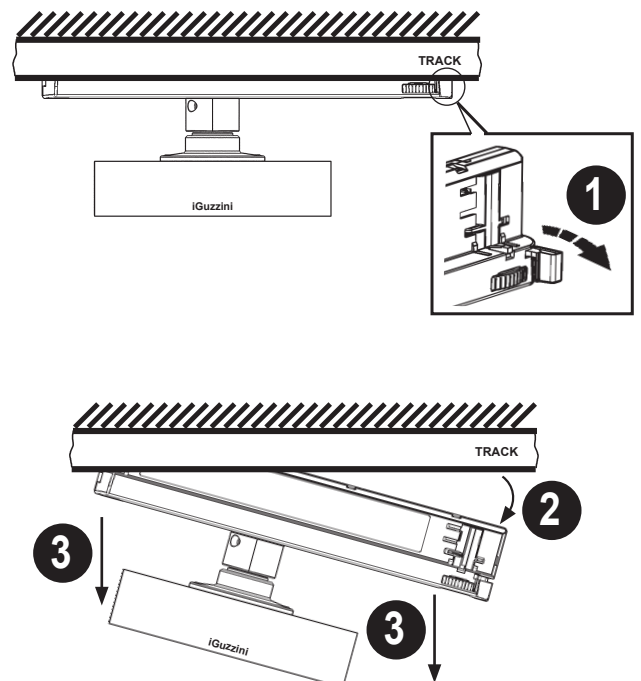

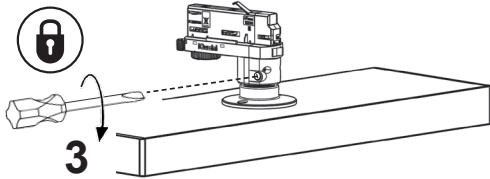
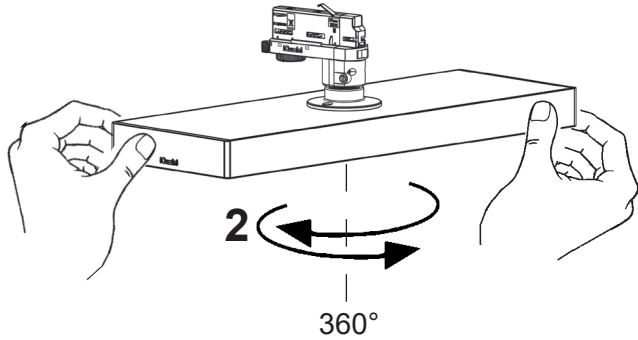
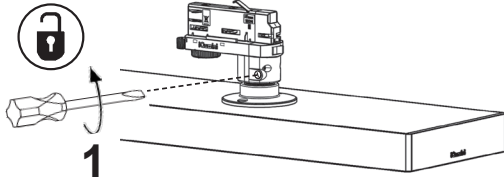

Version:

- DALI

- IT** Tra i conduttori di alimentazione e quelli di controllo è garantito un isolamento fondamentale.
- EN** Insulation is guaranteed between the power supply wires and the control wires basic.
- FR** Entre les conducteurs d'alimentation et les conducteurs de commande, une isolation est garantie fondamentale.
- DE** Zwischen den Versorgungs- und Steuerungsleitern ist eine Isolierung Basis gewährleistet.
- NL** Tussen de geleiders van de voeding en de controle wordt een isolatie gewaarborgd fundamenteel.
- ES** Entre los conductores de alimentación y los de control está garantizado el aislamiento fundamental.
- DA** Der er garanteret en isolering grundlæggende imellem forsyningslederne og styrelederne.
- NO** Det garanteres en isolering fundamental mellom strømlederne og kontrollederne.
- SV** Det garanteras isolering grundläggande mellan matningsledare och kontrollkablar.
- RU** Гарантируется развязка цепей питания и управления фундаментальная.
- ZH** 电源线和控制线之间有绝缘保证基本。
- AR** يتم ضمان العزل بين موصلات التغذية بالطاقة وموصلات التحكم المزوج

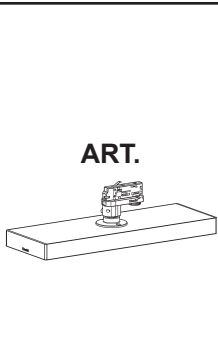

carico dali / dali load charge dali (courant maxi admissible) dali-last dali vermogen carga dali dali strømstyrke belastning for "dali" dali-belastning макс. ток системы dali с регуляцией интенсивности света DALI 智能调光系统允许的最大 电流量 DALI شحنة / جمل	indirizzi dali dali addresses adresses dali dali-adressen dali adressen direcciones dali dali adresser adresser til "dali" dali-adresser логические адреса системы dali DALI 智能调光系统计算 机指定控制参数 DALI عناوين
1 (2 mA)	1

+ Art.

Version:

- DALI
- DALI-2
- ORGANIC RESPONSE

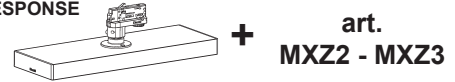

MXZ2

MXZ3

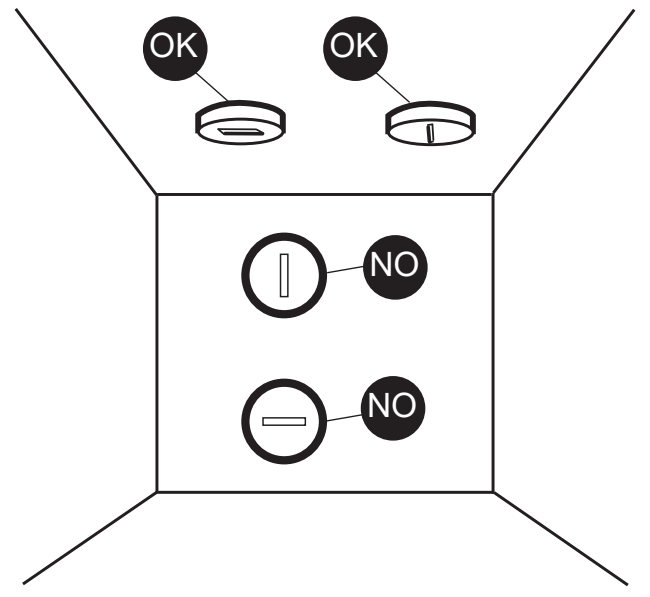
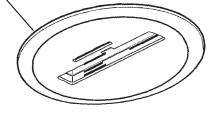
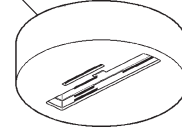

- IT** Per l'installazione con gli accessori art. MXZ2 - MXZ3 fare riferimento al foglio istruzioni relativo.
- EN** To install the product with accessories MXZ2 - MXZ3, please see the relevant instruction sheet.
- FR** En cas d'installation avec les accessoires art. MXZ2 - MXZ3, se conformer aux instructions de la feuille d'instructions correspondante.
- DE** Bezüglich der Installation mit den Zubehörteilen Art. MXZ2 - MXZ3 ziehen Sie das entsprechende Unterweisungsblatt zu Rate.
- NL** Voor het installeren van de accessoires art. MXZ2 - MXZ3 kunt u het betreffende instructieblaadje raadplegen.
- ES** Para la instalación con los accesorios art. MXZ2 - MXZ3 hágase referencia a la hoja de instrucciones.
- NO** For installation af ekstraudstyr art. MXZ2 - MXZ3 henvises til den pågældende brugsanvisning.
- DA** For installasjon av tilbehøret MXZ2 - MXZ3, vennligst se tilhørende instruksjonsark.
- SV** Angående installation med tillbehören MXZ2 - MXZ3 hänvisas till respektive instruktionsblad.
- RU** Порядок монтажа аксессуаров арт. MXZ2 - MXZ3 смотрите в соответствующих инструкциях.
- ZH** 安装配件 MXZ2 - MXZ3 的产品时，请参阅相关说明表。
- AR** لترتيب التجهيز بالملحقات MXZ2 - MXZ3 ارجع إلى ورقة التعليمات ذات الصلة.



- IT** N.B.: Per la sostituzione del LED contattare l'azienda iGuzzini.
- EN** N.B.: For information on LED replacement please contact iGuzzini.
- FR** N.B.: Pour procéder au remplacement de la LED, adressez-vous à la société iGuzzini.
- DE** N.B.: Bezüglich des Austausches der LED kontaktieren Sie bitte die Firma iGuzzini.
- NL** N.B.: Voor het vervangen van de LED neemt u contact op met het bedrijf iGuzzini.
- ES** NOTA: Para sustituir el LED llame a la empresa iGuzzini.
- DA** N.B.: For udskiftning af lysdioden, skal man kontakte iGuzzini.
- NO** N.B.: For informasjon om skifte av LED, vennligst ta kontakt med iGuzzini.
- SV** OBS! För byte av lysdioden, kontakta företaget iGuzzini.
- RU** ПРИМЕЧАНИЕ: Для замены СИДов обращайтесь в компанию iGuzzini.
- ZH** 注意: 如需LED更换的信息, 请联系iGuzzini
- AR** تنبيه: لاستبدال الضوء LED اتصل بشركة iGuzzini



Version:
- DALI
- DALI-2
- ORGANIC RESPONSE

IT Attenzione, rischio di scossa elettrica
EN Caution, risk of electric shock
FR Attention, risque de choc électrique
DE Achtung, Stromschlaggefahr
NL Let op, gevaar voor elektrische schok
ES Atención: riesgo de descarga eléctrica
DA Advarsel: Fare for elektrisk stød
NO Forsiktig! Fare for elektrisk stød
SV Observera, risk för elstöt
RU Внимание, риск поражения электрическим током
ZH 小心, 触电危险
AR

تنبيه، خطر الصدمة الكهربائية

Bluetooth

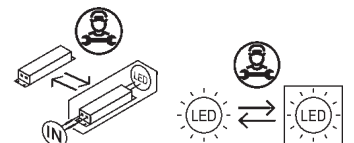
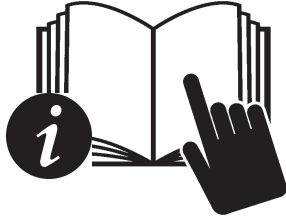

2.510.780.01 IS19974/01		iGuzini		fattore di potenza power factor facteur de puissance Leistungsfaktor vermogensfactor factor de potencia effektfaktor effektfaktor effektfaktor фактор мощности 功率因数 عمل القدرة	corrente assorbita absorbed current courant absorbé Stromaufnahme stroomopname corriente absorbida absorberet strøm absorbert strøm tilford strøm поглощаемая мощность 电源电流 التيار الممتص
ART.		λ	A		
RS69 - RS70 - RS71	.7S1 - .7S2	0,81	0,09		
	.7S3 - .7S4	0,80	0,09		
RS72	.7S1 - .7S2	0,79	0,08		
	.7S3 - .7S4	0,79	0,09		
RS73 - RS74	.7S1 - .7S2	0,85	0,10		
	.7S3 - .7S4	0,85	0,10		
RS75 - RS76	.7S1 - .7S2	0,83	0,10		
	.7S3 - .7S4	0,84	0,10		
RS85 - PZ44 - PZ45 - PZ46 - RT65 - RT66 RT67 - RT68 - PY79 - PY80 - PY81 - PY82 PY87 - PY88 - PY89 - PY90	.7S1 - .7S2	>0,9	0,14		
	.7S3 - .7S4	>0,9	0,15		
RS86 - RS87 - RS88 - PZ51 - PZ52 - PZ53 - PZ54	.7S1 - .7S2	>0,9	0,13		
	.7S3 - .7S4	>0,9	0,14		
RS89 - RS90 - RS91 - PZ50 - PZ55 - PZ56 - PZ57	.7S1 - .7S2	>0,9	0,15		
	.7S3 - .7S4	>0,9	0,17		
RS92 - PZ58	.7S1 - .7S2	>0,9	0,14		
	.7S3 - .7S4	>0,9	0,16		
RS77 - RS78 - RS79 - RS80	.7S1 - .7S2	>0,9	0,08		
	.7S3 - .7S4	>0,95	0,09		
RS81	.7S1 - .7S2	>0,9	0,09		
	.7S3 - .7S4	>0,95	0,10		
RS82	.7S1 - .7S2	>0,95	0,10		
	.7S3 - .7S4	>0,95	0,10		
RS83 - RS84	.7S1 - .7S2	>0,95	0,09		
	.7S3 - .7S4	>0,95	0,10		
RS93	.7S1 - .7S2	>0,95	0,15		
	.7S3 - .7S4	>0,95	0,15		
RS94 - RS95 - RS96	.7S1 - .7S2	>0,95	0,12		
	.7S3 - .7S4	>0,95	0,14		
RS97 - RS98 - RS99	.7S1 - .7S2	>0,95	0,15		
	.7S3 - .7S4	>0,95	0,17		
RT00	.7S1 - .7S2	>0,95	0,14		
	.7S3 - .7S4	>0,95	0,16		
PZ27 - PZ28 - PZ29	.7S1 - .7S2	0,80	0,09		
	.7S3 - .7S4	0,80	0,10		
PZ30	.7S1 - .7S2	0,79	0,09		
	.7S3 - .7S4	0,80	0,10		
PZ31 - PZ32	.7S1 - .7S2	0,83	0,10		
	.7S3 - .7S4	0,86	0,10		
PZ33 - PZ34	.7S1 - .7S2	0,82	0,10		
	.7S3 - .7S4	0,85	0,10		
PZ43	.7S1 - .7S2	>0,9	0,15		
	.7S3 - .7S4	>0,9	0,16		
PZ47 - PZ48 - PZ49	.7S1 - .7S2	>0,9	0,16		
	.7S3 - .7S4	>0,9	0,18		
PZ35 - PZ36 - PZ37	.7S1 - .7S2	0,78	0,08		
	.7S3 - .7S4	0,80	0,09		
PZ38	.7S1 - .7S2	0,76	0,08		
	.7S3 - .7S4	0,80	0,09		
PZ39 - PZ40	.7S1 - .7S2	0,83	0,10		
	.7S3 - .7S4	0,85	0,10		
PZ41 - PZ42	.7S1 - .7S2	0,81	0,09		
	.7S3 - .7S4	0,84	0,10		
RT69 - RT70 - PY83 - PY84 - PY91 - PY92	.7S1 - .7S2	>0,9	0,17		
	.7S3 - .7S4	>0,95	0,19		
RT71 - RT72	.7S1 - .7S2	>0,9	0,15		
	.7S3 - .7S4	>0,9	0,18		
RT81 - PY95	.7S1 - .7S2	>0,95	0,25		
	.7S3 - .7S4	>0,95	0,27		
RT82 - RT83 - RT84	.7S1 - .7S2	>0,95	0,23		
	.7S3 - .7S4	>0,95	0,26		
RT85 - RT86 - PY99 - PZ00 - PZ01	.7S1 - .7S2	>0,95	0,28		
	.7S3 - .7S4	>0,95	0,30		
RT87 - RT93 - RT94	.7S1 - .7S2	>0,95	0,30		
	.7S3 - .7S4	>0,95	0,30		
RT88 - PZ02	.7S1 - .7S2	>0,95	0,26		
	.7S3 - .7S4	>0,95	0,30		
RT73 - RT74 - RT75 - RT76	.7S1 - .7S2	>0,95	0,30		
	.7S3 - .7S4	>0,95	0,34		
RT77 - RT78 - RT79 - RT80	.7S1 - .7S2	>0,95	0,33		
	.7S3 - .7S4	>0,95	0,38		
RT89	.7S1 - .7S2	>0,95	0,26		
	.7S3 - .7S4	>0,95	0,28		
RT90 - RT91 - RT92	.7S1 - .7S2	>0,95	0,24		
	.7S3 - .7S4	>0,95	0,27		
RT95 - RT96	.7S1 - .7S2	>0,95	0,28		
	.7S3 - .7S4	>0,95	0,32		
PY85 - PY86 - PY93 - PY94	.7S1 - .7S2	>0,9	0,16		
	.7S3 - .7S4	>0,95	0,18		
PY96 - PY97 - PY98	.7S1 - .7S2	>0,95	0,24		
	.7S3 - .7S4	>0,95	0,26		

2.510.780.01 IS19974/01		iGuzini		fattore di potenza power factor facteur de puissance Leistungsfaktor vermogensfactor factor de potencia effektfaktor effektfaktor effektfaktor фактор мощности 功率因数 عمل القدرة	corrente assorbita absorbed current courant absorbé Stromaufnahme stroomopname corriente absorbida absorberet strøm absorbert strøm tilford strøm поглощаемая мощность 电源电流 التيار الممتص
ART.		λ	A		
RS69 - RS70 - RS71	.7S1 - .7S2	0,81	0,09		
	.7S3 - .7S4	0,80	0,09		
RS72	.7S1 - .7S2	0,79	0,08		
	.7S3 - .7S4	0,79	0,09		
RS73 - RS74	.7S1 - .7S2	0,85	0,10		
	.7S3 - .7S4	0,85	0,10		
RS75 - RS76	.7S1 - .7S2	0,83	0,10		
	.7S3 - .7S4	0,84	0,10		
RS85 - PZ44 - PZ45 - PZ46 - RT65 - RT66 RT67 - RT68 - PY79 - PY80 - PY81 - PY82 PY87 - PY88 - PY89 - PY90	.7S1 - .7S2	>0,9	0,14		
	.7S3 - .7S4	>0,9	0,15		
RS86 - RS87 - RS88 - PZ51 - PZ52 - PZ53 - PZ54	.7S1 - .7S2	>0,9	0,13		
	.7S3 - .7S4	>0,9	0,14		
RS89 - RS90 - RS91 - PZ50 - PZ55 - PZ56 - PZ57	.7S1 - .7S2	>0,9	0,15		
	.7S3 - .7S4	>0,9	0,17		
RS92 - PZ58	.7S1 - .7S2	>0,9	0,14		
	.7S3 - .7S4	>0,9	0,16		
RS77 - RS78 - RS79 - RS80	.7S1 - .7S2	>0,9	0,08		
	.7S3 - .7S4	>0,95	0,09		
RS81	.7S1 - .7S2	>0,9	0,09		
	.7S3 - .7S4	>0,95	0,10		
RS82	.7S1 - .7S2	>0,95	0,10		
	.7S3 - .7S4	>0,95	0,10		
RS83 - RS84	.7S1 - .7S2	>0,95	0,09		
	.7S3 - .7S4	>0,95	0,10		
RS93	.7S1 - .7S2	>0,95	0,15		
	.7S3 - .7S4	>0,95	0,15		
RS94 - RS95 - RS96	.7S1 - .7S2	>0,95	0,12		
	.7S3 - .7S4	>0,95	0,14		
RS97 - RS98 - RS99	.7S1 - .7S2	>0,95	0,15		
	.7S3 - .7S4	>0,95	0,17		
RT00	.7S1 - .7S2	>0,95	0,14		
	.7S3 - .7S4	>0,95	0,16		
PZ27 - PZ28 - PZ29	.7S1 - .7S2	0,80	0,09		
	.7S3 - .7S4	0,80	0,10		
PZ30	.7S1 - .7S2	0,79	0,09		
	.7S3 - .7S4	0,80	0,10		
PZ31 - PZ32	.7S1 - .7S2	0,83	0,10		
	.7S3 - .7S4	0,86	0,10		
PZ33 - PZ34	.7S1 - .7S2	0,82	0,10		
	.7S3 - .7S4	0,85	0,10		
PZ43	.7S1 - .7S2	>0,9	0,15		
	.7S3 - .7S4	>0,9	0,16		
PZ47 - PZ48 - PZ49	.7S1 - .7S2	>0,9	0,16		
	.7S3 - .7S4	>0,9	0,18		
PZ35 - PZ36 - PZ37	.7S1 - .7S2	0,78	0,08		
	.7S3 - .7S4	0,80	0,09		
PZ38	.7S1 - .7S2	0,76	0,08		
	.7S3 - .7S4	0,80	0,09		
PZ39 - PZ40	.7S1 - .7S2	0,83	0,10		
	.7S3 - .7S4	0,85	0,10		
PZ41 - PZ42	.7S1 - .7S2	0,81	0,09		
	.7S3 - .7S4	0,84	0,10		
RT69 - RT70 - PY83 - PY84 - PY91 - PY92	.7S1 - .7S2	>0,9	0,17		
	.7S3 - .7S4	>0,95	0,19		
RT71 - RT72	.7S1 - .7S2	>0,9	0,15		
	.7S3 - .7S4	>0,9	0,18		
RT81 - PY95	.7S1 - .7S2	>0,95	0,25		
	.7S3 - .7S4	>0,95	0,27		
RT82 - RT83 - RT84	.7S1 - .7S2	>0,95	0,23		
	.7S3 - .7S4	>0,95	0,26		
RT85 - RT86 - PY99 - PZ00 - PZ01	.7S1 - .7S2	>0,95	0,28		
	.7S3 - .7S4	>0,95	0,30		
RT87 - RT93 - RT94	.7S1 - .7S2	>0,95	0,30		
	.7S3 - .7S4	>0,95	0,30		
RT88 - PZ02	.7S1 - .7S2	>0,95	0,26		
	.7S3 - .7S4	>0,95	0,30		
RT73 - RT74 - RT75 - RT76	.7S1 - .7S2	>0,95	0,30		
	.7S3 - .7S4	>0,95	0,34		
RT77 - RT78 - RT79 - RT80	.7S1 - .7S2	>0,95	0,33		
	.7S3 - .7S4	>0,95	0,38		
RT89	.7S1 - .7S2	>0,95	0,26		
	.7S3 - .7S4	>0,95	0,28		
RT90 - RT91 - RT92	.7S1 - .7S2	>0,95	0,24		
	.7S3 - .7S4	>0,95	0,27		
RT95 - RT96	.7S1 - .7S2	>0,95	0,28		
	.7S3 - .7S4	>0,95	0,32		
PY85 - PY86 - PY93 - PY94	.7S1 - .7S2	>0,9	0,16		
	.7S3 - .7S4	>0,95	0,18		
PY96 - PY97 - PY98	.7S1 - .7S2	>0,95	0,24		
	.7S3 - .7S4	>0,95	0,26		

- I Istruzioni per le operazioni di servizio per l'apparecchio di illuminazione**
GB Instructions on luminaire service operations
F Instructions pour les opérations de service du luminaire
D Wartungsanleitung für die Leuchte
NL Instructies voor de onderhoudsoperaties op de verlichtingsarmatuur
E Instrucciones para las operaciones de servicio del aparato de alumbrado
DK Anvisninger i serviceindgreb på belysningsarmatur
N Anvisninger for betjening av lysapparatet
S Instruktioner för användning av belysningsanordningen
RUS Инструкции по эксплуатации осветительного прибора
CN 照明装置检修操作说明

Sostituire la lampada parzialmente esausta
 Replace the partly exhausted lamp
 Remplacer la lampe partiellement épuisée
 Die teilweise erschöpfte Lampe austauschen
 Vervang de gedeeltelijk lege lamp
 Sustituir la lámpara parzialmente agotada
 Udskift den delvist udtjente pære
 Skifte ut den delvis utbrænte lyspæren
 Byt ut den delvis förbrukade lampan
 Замена частично отработанной лампочки
 更换部分老化的灯泡



Spegnimento
 Switch it off
 Extinction
 Ausschaltung
 Uitschakeling
 Apagado
 Slukning
 Slukking
 Släckning
 Выключение
 关灯

Interrompere l'alimentazione dell'apparecchio
 Cut the power supply to the luminaire
 Couper l'alimentation du luminaire
 Stromversorgung der Leuchte unterbrechen
 Onderbreek de voeding van het apparaat
 Interrumpir la alimentación del aparato
 Afbryd armaturets strømforsyning
 Avbryte strømtilførselen til apparatet
 Koppla från anordningens strömförsörjning
 Отключить электропитание прибора
 中断装置供电



Aprire l'apparecchio
 Open the fixture
 Ouvrir le luminaire
 Das Gerät öffnen
 Open het apparaat
 Abrir el aparato
 Åbn armaturet
 Åpne apparatet
 Öppna anordningen
 Раскрыть прибор
 打开装置



Rimuovere la lampada esausta
 Remove the exhausted lamp
 Retirer la lampe épuisée
 Die alte Lampe entnehmen
 Verwijder de lege lamp
 Quitar la lámpara agotada
 Tag den udtjente pære ud
 Fjerne den utbrænte lyspæren
 Ta bort den förbrukade lampan
 Вынуть старую лампочку
 取出老化的灯泡

Portarla in un centro di riciclaggio
 Carry it to a recycling centre
 La porter dans une déchetterie pour son recyclage
 Ordnungsgemäß entsorgen
 Breng de lamp naar een recyclingcentrum
 Llevarla a un centro de reciclaje
 Aflever den på en genbrugsstation
 Lever den til en miljøstasjon
 Lämna in den till en återvinningsanläggning
 Сдать ее в пункт приема утильсырья
 将其送往回收中心



Inserire la nuova lampada
 Introduce the new lamp
 Installer la lampe neuve
 Die neue Lampe einsetzen
 Doe de nieuwe lamp op zijn plek
 Montar la nueva lámpara
 Sæt den nye pære i
 Sette i den nye pæren
 Sätt i den nya lampan
 Вставить новую лампочку
 装入新灯泡

Inserire la nuova lampada nel portalampana
 Fit the new lamp into the socket
 Installer la nouvelle lampe dans le support de lampe
 Die neue Lampe in den Sockel einsetzen
 Doe de nieuwe lamp in de lamphouder
 Montar la nueva lámpara en el portalampana
 Sæt den nye pære i fatningen
 Sette den nye pæren inn i lampeholderen
 Sätt i den nya lampan i lamphållaren
 Вставить новую лампочку в патрон
 将新灯泡插入灯泡架中



Riposizionare ottica
 Re-place the optic
 Remettre l'optique à sa place
 Die Optik wieder einsetzen
 Doe de optiek weer op zijn plaats
 Volver a montar la óptica
 Sæt den optiske enhed på plads
 Innstille linsen
 Flytta om optiken
 Отрегулировать линзы
 重新定位光头



Effettuare prova di funzionamento
 Perform operative test
 Procéder à un essai de fonctionnement
 Eine Funktionsprüfung durchführen
 Controleer de correcte werking
 Hacer una prueba de funcionamiento
 Afprøv funktionen
 Prøve om den fungerer
 Utför funktionstest
 Выполнить проверку исправности работы
 执行功能测试



- I Istruzioni per la pulizia dell'apparecchio di illuminazione
 GB Instructions on luminaire cleaning operations
 F Instructions pour le nettoyage du luminaire
 D Anweisungen zur Reinigung der Leuchte
 NL Instructies voor de reiniging van de verlichtingsarmatuur
 E Instrucciones para limpiar el aparato de alumbrado
 DK Anvisninger i rengøring af belysningsarmaturet
 N Anvisninger for rengjøring av lysapparatet
 S Instruktioner för rengöring av belysningsanordningen
 RUS Инструкции по чистке осветительного прибора
 CN 照明装置清洁说明

Pulire l'apparecchio
 Clean the fixture
 Nettoyer le luminaire
 Das Gerät reinigen
 Reinig het apparaat
 Limpiar el aparato
 Rengør armaturet
 Rengjøre apparatet
 Rengör anordningen
 Чистка прибора
 清洁装置



Spegnimento
 Switch it off
 Extinction
 Ausschaltung
 Uitschakeling
 Apagado
 Slukning
 Slukking
 Släckning
 Выключение
 关灯

Interrompere l'alimentazione dell'apparecchio
 Cut the power supply to the luminaire
 Couper l'alimentation du luminaire
 Stromversorgung der Leuchte unterbrechen
 Onderbreek de voeding van het apparaat
 Interrumpir la alimentación del aparato
 Afbryd armaturets strømforsyning
 Avbryt strømtilførselen til apparatet
 Koppla från anordningens strömförsörjning
 Отключить электропитание прибора
 中断装置供电



Spolverare l'ottica esterna
 Remove dust from the external optic
 Dépoussiérer l'optique extérieure
 Die externe Optik abstauben
 Stof de externe optiek af
 Quitar el polvo de la óptica exterior
 Tør støvet af den udvendige optiske enhed
 Fjerne støv fra den eksterne lysenheden
 Damma av den yttre optiken
 Вытереть пыль с внешней стороны линз
 为外侧镜头掸尘



Lavare l'ottica esterna
 Wash the external optic
 Laver l'optique extérieure
 Die externe Optik waschen
 Was de externe optiek
 Lavar la óptica exterior
 Vask den udvendige optiske enhed
 Vaske den eksterne lysenheden
 Rengör den yttre optiken
 Вымыть линзы с внешней стороны
 清洁外镜头



Rimuovere l'ottica
 Remove the optic
 Retirer l'optique
 Die Optik abnehmen
 Verwijder de optiek
 Quitar la óptica
 Tag den optiske enhed af
 Fjerne lysenheden
 Ta bort optiken
 Снять линзы
 取下镜头



Pulire la parte interna dell'apparecchio di illuminazione
 Clean the inside of the fixture
 Nettoyer l'intérieur du luminaire
 Die Innenseite der Leuchte reinigen
 Reinig de binnenzijde van de verlichtingsarmatuur
 Limpiar el interior del aparato de alumbrado
 Rengør belysningsarmaturets indvendige dele
 Rengjøre lysapparatet innvendig
 Rengör belysningsanordningen invändigt
 Протереть осветительный прибор изнутри
 清洁照明装置内部



Riposizionare ottica
 Re-place the optic
 Remettre l'optique à sa place
 Die Optik wieder einsetzen
 Doe de optiek weer op zijn plaats
 Volver a montar la óptica
 Sæt den optiske enhed på plads
 Innstille linsen
 Flytta om optiken
 Отрегулировать линзы
 重新定位镜头



Effettuare prova di funzionamento
 Perform operative test
 Procéder à un essai de fonctionnement
 Eine Funktionsprüfung durchführen
 Controleer de correcte werking
 Hacer una prueba de funcionamiento
 Afprøv funktionen
 Prøve om den fungerer
 Utför funktionstest
 Выполнить проверку исправности работы
 执行功能测试

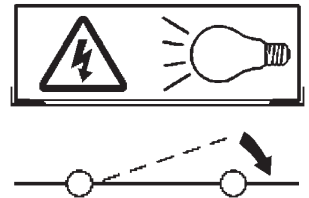

- I Istruzioni per il fine vita e lo smaltimento dei componenti
- GB Instructions on end-of-life and component disposal
- F Instructions pour la gestion des composants en fin de vie et leur mise au rebut
- D Anweisungen zur Entsorgung der Leuchtenkomponenten
- NL Instructies voor het verwijderen van de armatuur en het recyclen van de onderdelen
- E Instrucciones para el final de vida y la eliminación los componentes
- DK Anvisninger i udtjent armatur og bortskaffelse af komponenter
- N Anvisninger for endt levetid og avfallsbehandling av delene
- S Instruktioner vid bortskaffning och kassering av komponenter
- RUS Инструкции по утилизации прибора и его комплектующих по окончании его срока службы
- CN 寿命期结束与零件废弃处置说明

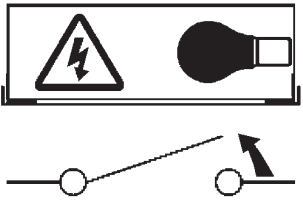
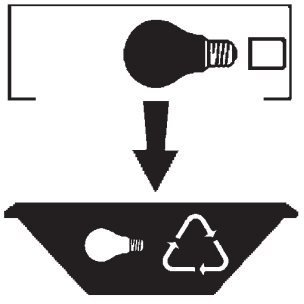
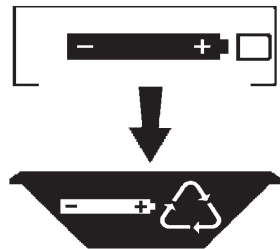
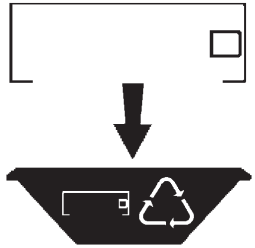
<p>Spegnimento Switch it off Extinction Ausschaltung Uitschakeling Apagado Slukning Slukking Släckning Выключение 关灯</p> <p>Interrompere l'alimentazione dell'apparecchio Cut the power supply to the luminaire Couper l'alimentation du luminaire Stromversorgung der Leuchte unterbrechen Onderbreek de voeding van het apparaat Interrompirla alimentación del aparato Afbryd armaturets strømforsyning Avbryt strømtilførselen til apparatet Koppla från anordningens strömförsörjning Отключить электропитание прибора 中断装置供电</p> 	<p>Rimuovere la/e lampada/e per la dismissione Remove the lamp(s) for decommissioning Retirer la(les) lampe(s) pour sa(leur) mise au rebut Die Lampe/n ordnungsgemäß entsorgen Verwijder de lamp(en) voor het recyclen Quitar la(s) lámpara(s) para el desecho Tag pæren/pærerne ud til bortskaffelse Fjerne lampen/-e som skal kastes Ta bort lampan/-orna för bortskaffningen Вынуть лампочку/и для утилизации прибора 取出需要丢弃的灯泡</p> 	<p>Rimuovere la batteria per la dismissione Remove the battery for decommissioning Retirer la batterie pour sa mise au rebut Die Batterie ordnungsgemäß entsorgen Verwijder de batterij voor het recyclen Quitar la batería para el desecho Tag batteriet ud til bortskaffelse Fjerne batteriet som skal kastes Ta bort batteriet för bortskaffningen Вынуть батарейку для утилизации прибора 取出需要丢弃的电池</p> 	<p>Rimuovere l'apparecchio per la dismissione Remove the fixture for decommissioning Enlever le luminaire pour sa mise au rebut Das Gerät ordnungsgemäß entsorgen Verwijder het apparaat voor het recyclen Quitar el aparato para el desecho Tag armaturet ud til bortskaffelse Fjerne apparatet som skal kastes Ta bort anordningen för bortskaffningen Снять прибор для утилизации 取出需要丢弃的装置</p> 
---	--	--	--

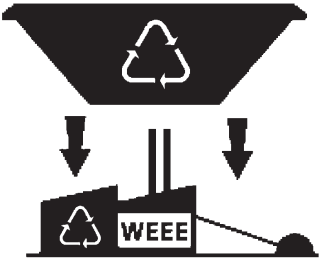
<p>Inviare i materiali ad un centro di raccolta RAEE Send the materials to a WEEE collection centre Envoyer les matériaux dans une déchetterie DEEE Die Materialien in einem WEEE-Zentrum entsorgen Zend de materialen naar een recyclingscentrum voor de AEEA Enviar los materiales a un centro de recogida RAEE Aflever materialerne på et indsamlingscenter for elektronisk udstyr Sende materialene til en miljøstasjon for resirkulering av EE-avfall Skicka materialet till en RAEE uppsamlingscentral Сдать материалы в пункт приема утильсырья 将材料送往电气和电子垃圾回收中心</p> 			
--	--	--	--