

ISTRUZIONI PER GLI ACCESSORI DELLE SERIE "COLOUR WOODY" E "MAXY WOODY"
INSTRUCTIONS FOR THE ACCESSORIES IN THE "COLOUR WOODY" AND "MAXIWOODY"
RANGES

INSTRUCTIONS POUR LES ACCESSOIRES DES SERIES "COLOUR WOODY" ET "MAXIWOODY"
GEBRAUCHSHINWEISE FÜR DAS ZUBEHÖR DER SERIEN "COLOUR WOODY" UND
"MAXIWOODY"

INSTRUCTIES VOOR DE ACCESSOIRES VAN DE SERIE "COLOUR WOODY" EN "MAXIWOODY"

INSTRUCCIONES PARA LOS ACCESORIOS DE LAS SERIES "COLOUR WOODY" Y "MAXIWOODY"

ANVISNINGER TIL TILBEHØR TIL SERIERNE "COLOUR WOODY" OG "MAXY WOODY"

INSTRUKSJONER FOR TILBEHØR I SERIENE "COLOUR WOODY" OG "MAXIWOODY"

ANVISNINGAR FÖR TILLBEHÖR FÖR SERIEN "COLOUR WOODY" OCH "MAXY WOODY"

ИНСТРУКЦИИ ДЛЯ АКССЕССУАРОВ СЕРИЙ «COLOUR WOODY» И «MAXY WOODY»

"COLOUR WOODY"和"MAXIWOODY"系列附件的安装说明书

I ATTENZIONE:

LA SICUREZZA DELL'APPARECCHIO E' GARANTITA SOLO CON L'USO APPROPRIATO
DELLE SEGUENTI ISTRUZIONI; PERTANTO E' NECESSARIO CONSERVARLE.

GB WARNING:

THE SAFETY OF THIS FIXTURE IS GUARANTEED ONLY IF YOU COMPLY WITH
THESE INSTRUCTIONS; REMEMBER TO CONSERVE IN A SAFE PLACE.

F ATTENTION:

LA SECUTIE DE L'APPAREIL N'EST GARANTIE QU'EN CAS D'UTILISATION CORRECTE
DES INSTRUCTIONS SUIVANTES; IL FAUT PAR CONSEQUENT LES CONSERVER.

D ACHTUNG:

DIE SICHERHEIT DES GERÄTES WIRD NUR DURCH SACHGEMÄSSE BEFOLGUNG
NACHSTEHENDER ANWEISUNGEN GEWÄHRLEISTET; IHRE AUFBEWAHRUNG IST
DESHALB SEHR WICHTIG.

NL OPGELET:

DE VEILIGHEID VAN DI ATOESTEL IS SLECHTS DAN GEGARANDEERD ALS INDIEN
DE VOLGENDE INSTRUCTIES STRIKT WORDEN TOEGEPAST: DAAROM MOET MEN
ZE OOK BEWAREN.

E ATENCION:

LA SEGURIDAD DEL APARATO SE GARANTIZA SOLO CUMPLIENDO CUIDADOSAMEN-
TE LAS SIGUIENTES INSTRUCCIONES; POR ELLO, ES NECESARIO CONSERVARLAS.

DK BEMÆRK:

SIKKERHEDEN VED BRUG AF ARMATURET KAN KUN GARANTERES, HVIS DISSE
ANVISNINGER FØLGES; SØRG DERFOR FOR AT GEMME DEM.

N ADVARSEL:

SIKKERHETEN TIL DETTE APPARATET GARANTERES KUN HVIS DU OVERHOLDER
DISSE INSTRUKSJONENE; HUSK Å OPPBEVARE DEM PÅ ET TRYGT STED.

S OBSERVERA!

UTRUSTNINGENS SÄKERHET KAN ENDAST GARANTERAS OM DESSA ANVISNINGAR
RESPEKTERAS I DETALJ. SPARA DÄRFÖR DESSA ANVISNINGAR FÖR FRAMTIDA
KONSULTATION.

RUS ВНИМАНИЕ:

МЫ ГАРАНТИРУЕМ БЕЗОПАСНУЮ ЭКСПЛУАТАЦИЮ ИЗДЕЛИЯ ТОЛЬКО ПРИ
СОБЛЮДЕНИИ СЛЕДУЮЩИХ ИНСТРУКЦИЙ; С ЭТОЙ ЦЕЛЬЮ НЕОБХОДИМО
СОХРАНИТЬ ДАННУЮ БРОШЮРУ.

CN 警告

为确保该装置安全，请遵守操作指示；并于安全场所放置。

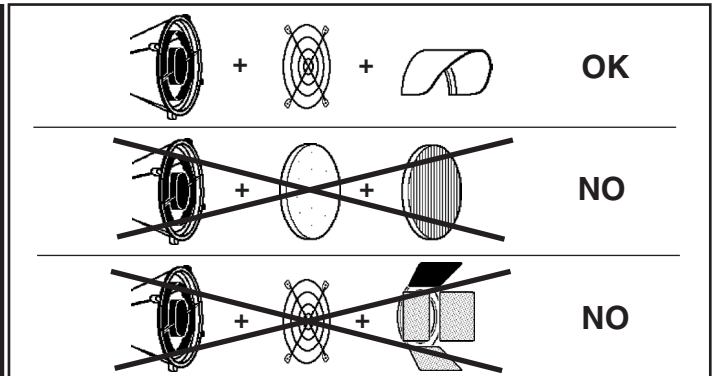











ART.	Filtro - Filter-Filtre Filter - Filter - Filtro Filtro - Filter- Filtro Фильтр - 濾片 art.											
5650	-	1158	1195	5943	5952	5940	5937	BZ09	BZ08	BZ23	BZ24	-
5651	-	1158	1195	5943	5952	5940	5937	BZ09	BZ08	BZ23	BZ24	-
5652	-	1158	1195	5943	5952	5940	5937	-	-	-	-	-
5653	-	1158	1195	5943	5952	5940	5937	-	-	-	-	-
5654	-	1158	1195	5943	5952	5940	5937	-	-	-	-	-
5655	-	1158	1195	5943	5952	5940	5937	-	-	-	-	-
5656	-	1158	1195	5943	5952	5940	5937	-	-	-	-	-
5657	-	1158	1195	5943	5952	5940	5937	-	-	-	-	-
5658	-	1159	1196	5944	5953	5941	5938	BZ26	BZ25	BZ27	BZ28	-
5659	-	1159	1196	5944	5953	5941	5938	BZ26	BZ25	BZ27	BZ28	-
5660	-	1159	1196	5944	5953	5941	5938	-	-	-	-	-
5661	-	1159	1196	5944	5953	5941	5938	-	-	-	-	-
5662	-	1159	1196	5944	5953	5941	5938	-	-	-	-	-
5663	-	1159	1196	5944	5953	5941	5938	-	-	-	-	-
5664	-	1159	1196	5944	5953	5941	5938	-	-	-	-	-
5665	-	1159	1196	5944	5953	5941	5938	-	-	-	-	-
5666	-	-	-	5944	-	-	-	-	-	-	-	-
5667	-	1160	1197	5945	5954	5942	5939	-	-	-	-	6176
5668	-	1160	1197	5945	5954	5942	5939	-	-	-	-	6176
5669	-	1160	1197	5945	5954	5942	5939	-	-	-	-	6176
5670	-	1160	1197	5945	5954	5942	5939	-	-	-	-	6176
5671*	1163	1160	1197	5945	5954	5942	5939	-	-	-	-	6176
5672*	1163	1160	1197	5945	5954	5942	5939	-	-	-	-	6176
5673*	1163	1160	1197	5945	5954	5942	5939	-	-	-	-	6176
5674*	1163	1160	1197	5945	5954	5942	5939	-	-	-	-	6176
5675	-	1158	1195	5943	5952	5940	5937	BZ09	BZ08	BZ23	BZ24	-
5676	-	1158	1195	5943	5952	5940	5937	BZ09	BZ08	BZ23	BZ24	-
5677	-	1158	1195	5943	5952	5940	5937	-	-	-	-	-
5678	-	1158	1195	5943	5952	5940	5937	-	-	-	-	-
5679	-	1158	1195	5943	5952	5940	5937	-	-	-	-	-
5680	-	1159	1196	5944	5953	5941	5938	BZ26	BZ25	BZ27	BZ28	-
5681	-	1159	1196	5944	5953	5941	5938	BZ26	BZ25	BZ27	BZ28	-
5682	-	1159	1196	5944	5953	5941	5938	-	-	-	-	-
5683	-	-	-	5944	-	-	-	-	-	-	-	-
5684	-	-	-	5943	-	-	-	-	-	-	-	-
5685	-	-	-	5943	-	-	-	-	-	-	-	-
5614	-	1158	1195	5943	5952	5940	5937	BZ09	BZ08	BZ23	BZ24	-
5615	-	1158	1195	5943	5952	5940	5937	BZ09	BZ08	BZ23	BZ24	-
5616	-	-	-	5943	-	-	-	-	-	-	-	-
5617	-	-	-	5943	-	-	-	-	-	-	-	-
5618	-	1159	1196	5944	5953	5941	5938	BZ26	BZ25	BZ27	BZ28	-
5619	-	1159	1196	5944	5953	5941	5938	BZ26	BZ25	BZ27	BZ28	-
5620	-	-	-	5944	-	-	-	-	-	-	-	-
5621	-	-	-	5944	-	-	-	-	-	-	-	-
5622	-	1160	1197	5945	5954	5942	5939	BZ30	BZ29	BZ31	BZ32	6176
5623	-	1160	1197	5945	5954	5942	5939	BZ30	BZ29	BZ31	BZ32	6176
5624	-	1160	1197	5945	5954	5942	5939	BZ30	BZ29	BZ31	BZ32	-

ART.	Filtro - Filter-Filtre - Filter Filter - Filter- Filtro-Filter Filter- Фильтр- 濾片 art.					
5739	-	1198	1196	5944	5941	5938
5740	-	1198	1196	5944	5941	5938
5741	1159	-	1196	5944	5941	5938
5742	1159	-	1196	5944	5941	5938
5745	-	1198	1196	5944	5941	5938
5746	-	1198	1196	5944	5941	5938
5747	1159	-	1196	5944	5941	5938
5748	1159	-	1196	5944	5941	5938
5751	-	1198	1196	5944	5941	5938
5752	-	1198	1196	5944	5941	5938
5753	1159	-	1196	5944	5941	5938
5754	1159	-	1196	5944	5941	5938
5757	-	1162	1197	5945	5942	5939
5758	-	1162	1197	5945	5942	5939
5759	-	1162	1197	5945	5942	5939
5760	-	1162	1197	5945	5942	5939
5761	-	1162	1197	5945	5942	5939
5762	-	1162	1197	5945	5942	5939



+

COLOUR WOODY

OK

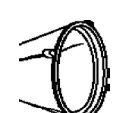
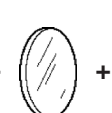

ART.										
	art.	art.	art.	art.	art.	art.	art.	art.	art.	art.
E981	1158 (65)	1195	6190	-	6193	6194	5937	5938	5943	6191
E982	1158 (65)	1195	6190	-	6193	6194	5937	5940	5943	6191
E983	1158 (65)	1195	6190	6192	-	6194	5937	5940	5943	-
E984	1158 (65)	1195	6190	6192	-	6194	5937	5940	5943	-
E985	1158 (65)	1195	6190	6192	6193	-	5937	5940	5943	-
E986	1158 (65)	1195	6190	6192	6193	-	5937	5940	5943	-
BV00	1158	1195	6190	-	6193	6194	5937	5938	5943	6191
BV01	1158	1195	6190	-	6193	6194	5937	5940	5943	6191
BV02	1158	1195	6190	6192	-	6194	5937	5940	5943	-
BV03	1158	1195	6190	6192	-	6194	5937	5940	5943	-
BV04	1158	1195	6190	6192	6193	-	5937	5940	5943	-
BV05	1158	1195	6190	6192	6193	-	5937	5940	5943	-
BV52	-	-	-	-	-	-	5937	5940	5943	-
BV53	-	-	-	-	-	-	5937	5940	5943	-
BV54	-	-	-	-	-	-	5937	5940	5943	-
BV55	-	-	-	-	-	-	5937	5940	5943	-

MAXIWOODY

 +  +  **OK**

art.BV00 - BV01
BV02 - BV03
BV04 - BV05

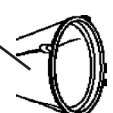
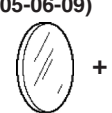
(05-06-09) (65)

 +  +  **OK**

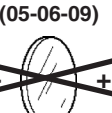
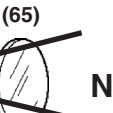

art.E981 - E982
E983 - E984
E985 - E986

(05-06-09) (65)

~~ +  + ~~ **NO**

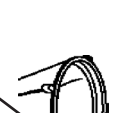
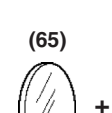

art.E981 - E982
E983 - E984
E985 - E986



(65)

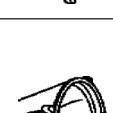
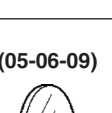

 +  +  **OK**

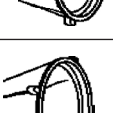
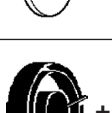

art.BV00 - BV01
BV02 - BV03
BV04 - BV05

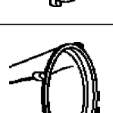

(05-06-09)

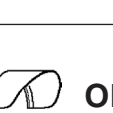

 +  +  **OK**

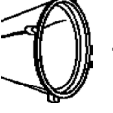
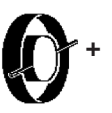

 +  +  **OK**

 +  +  **OK**

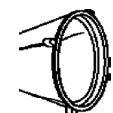

 +  +  **OK**

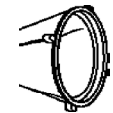
 +  +  **OK**

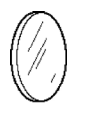
 +  +  **OK**

 +  +  **OK**

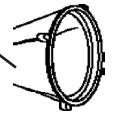
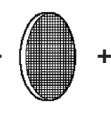
art.BV00
BV01
E981
E982

 +  +  **OK**



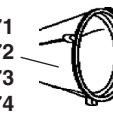
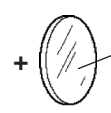

* art. 5671
5672
5673
5674

 + 

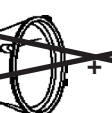

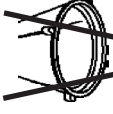

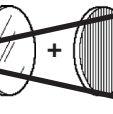
Colorato - Coloured - Couleur
Farbig - Gekleurd - Colorado
Farvet - Farget - Färgat
Цветной - 带颜色的
(065)NITRIC
ART. 1160

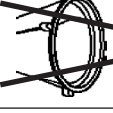
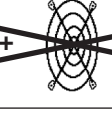
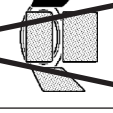

art.BV00
BV01



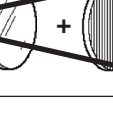

~~ + ~~ **NO**

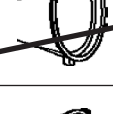
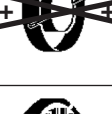
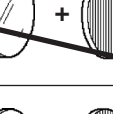

~~ +  +  + ~~ **NO**

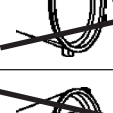

~~ +  + ~~ **NO**

~~ +  +  + ~~ **NO**

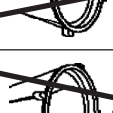
~~ +  +  + ~~ **NO**

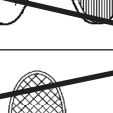
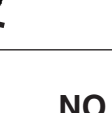

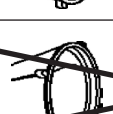
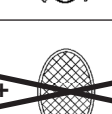

~~ +  +  + ~~ **NO**

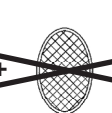
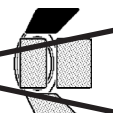
~~ +  +  + ~~ **NO**

~~ +  + ~~ **NO**

~~ +  + ~~ **NO**

MAXIWOODY 600W/1000W

art.				
art.	art.	art.	art.	art.
6167 + 6171 6168 + 6171 6169 + 6171	5945	5942	5935	6176
6167 + 6172 6168 + 6172 6169 + 6172	5945	5942	5935	6176



NO

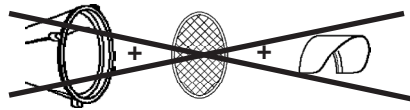

NO

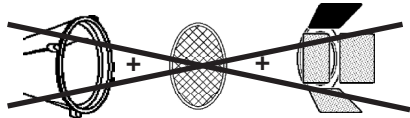

NO

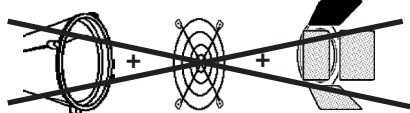

NO

I **N.B.** Si consiglia di effettuare le operazioni d'installazione o di manutenzione all'interno del vano ottico, in ambienti interni o quanto meno in assenza di umidità o pioggia.

GB **N.B.:** Installation and maintenance operations must be carried out inside the optical assembly, indoor and in a place with no humidity or rain.

F **N.B.:** Pour effectuer les opérations d'installation ou d'entretien des composants intérieurs du bloc optique, il est conseillé de se rendre dans un espace clos, ou tout du moins à l'abri de l'humidité ou de la pluie.

D **Hinweis:** Es empfiehlt sich, alle Installations- oder Wartungseingriffe am Leuchtgehäuse in geschlossenen Räumen bzw. bei trockenen Luftverhältnissen vorzunehmen (Feuchtigkeit und Regen vermeiden).

NL **N.B.:** We raden u aan de installatie- of onderhoudshandelingen van de optische behuizing binnenshuis uit te voeren, of in ieder geval in een omgeving waar geen vocht of regen is.

E **N.B.:** Se recomienda efectuar las operaciones de instalación o mantenimiento dentro del cuerpo óptico, en interiores o por lo menos en ausencia de humedad o lluvia.

DK **N.B.** Det anbefales at udføre installation eller vedligeholdelse inden i den optiske enhed indendør på et område fri for fugt og regn.

N **N.B.:** Det anbefales å utgjøre installasjons- eller vedlikeholdsinngrepene inne i det optiske rommet, innendørs eller i hvert fall der det ikke finnes fuktighet eller regn.

S **OBS!** Det rekommenderas att utföra installations- eller underhållsinsgrepp inuti det optiska rummet inomhus eller åtminstone i avsaknad av fukt eller regn..

RUS **ПРИМЕЧАНИЕ:** Рекомендуется выполнять монтаж или техническое обслуживание внутри лампового отсека в закрытых помещениях или по крайней мере в отсутствие влаги или атмосферных осадков.

CN 注释：建议在光学空间内部进行安装或者维修操作至少在内部环境或者不存在雨水或潮湿的环境。

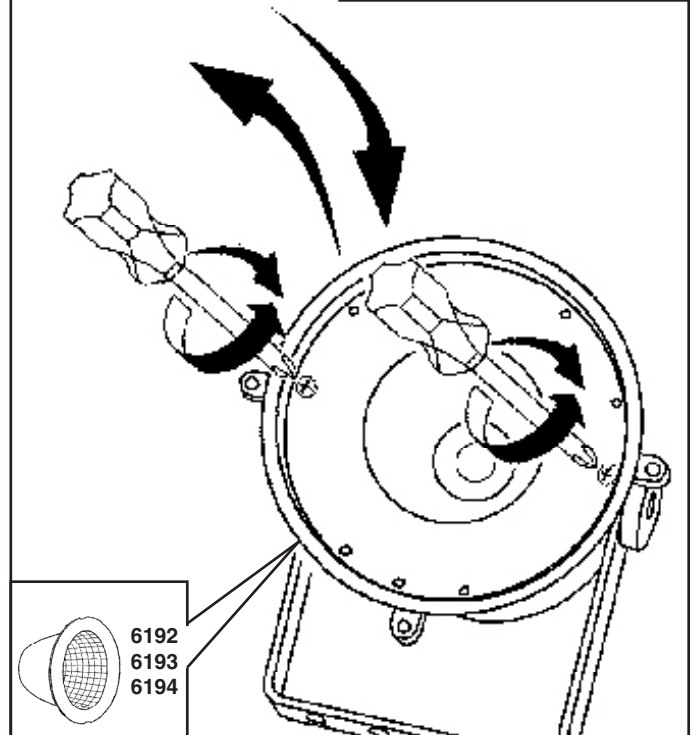
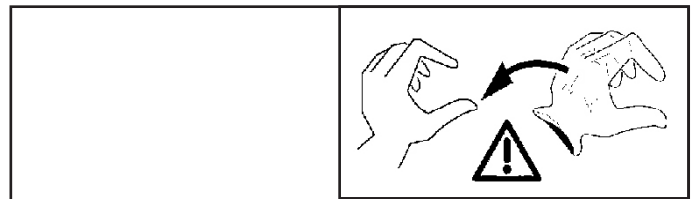
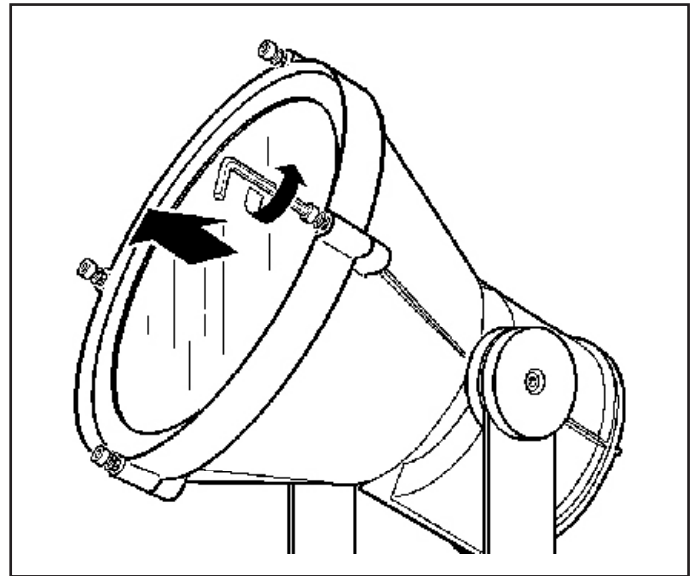
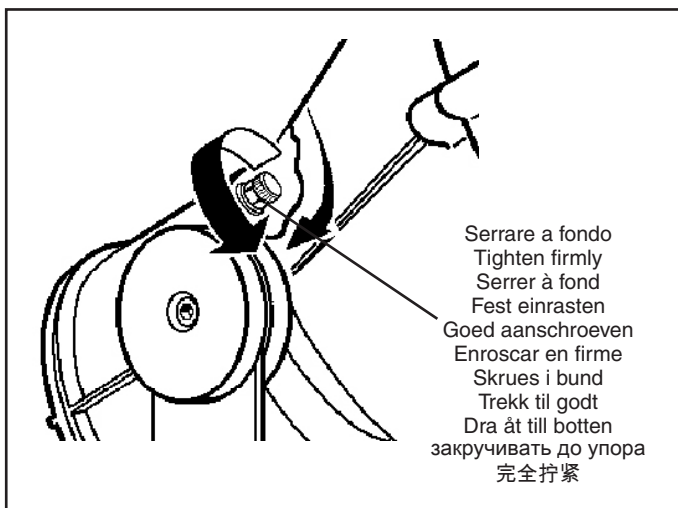

MAXIWOODY

I Le molle di sostegno per i filtri hanno due sedi ad altezze differenti. Questo permette di installare contemporaneamente filtri colorati e diffusori.

GB The springs supporting the filters have two housings and different heights. This makes it possible to install coloured filters and diffusers at the same time.

F Les ressorts support de filtres ont deux logements situés à des hauteurs différentes. Ceci permet d'installer à la fois des filtres colorés et des diffuseurs.

D Die Filterhaltefedern befinden sich an zweierlei Stellen in unterschiedlicher Höhe. So lassen sich gleichzeitig Farbfilter und Diffusoren einsetzen.

NL De veren ter ondersteuning van de filters hebben twee behuizingen op verschillende hoogten. Dit biedt de mogelijkheid tegelijkertijd gekleurde filters en lichtschermen te installeren.

E Los muelles de soporte para los filtros tiene dos alojamientos a una altura diferente. Esto permite la instalación simultánea de filtros cromáticos y difusores.

DK Fjødrene til montering af filtrene har to sæder med forskellig højde. Det gør det muligt at installere farvefilter og lyspredere samtidig.

N Fjødrene som støtter filtrene har to rammer og ulike høyder. Dette gjør det mulig å installere fargede filtre og diffusere samtidig.

S Filtrens stödfjädrar har två säten för olika höjder. Detta medger att installera färgade filter och ljusspridare samtidigt.

RUS В опорных пружинах фильтров имеются два гнезда, расположенные на разной высоте. Это позволяет одновременно установить цветные фильтры и диффузоры.

CN 支撑滤光器的弹簧有两个高度不同的机架，因此可以同时安装彩色滤光器和散射器。

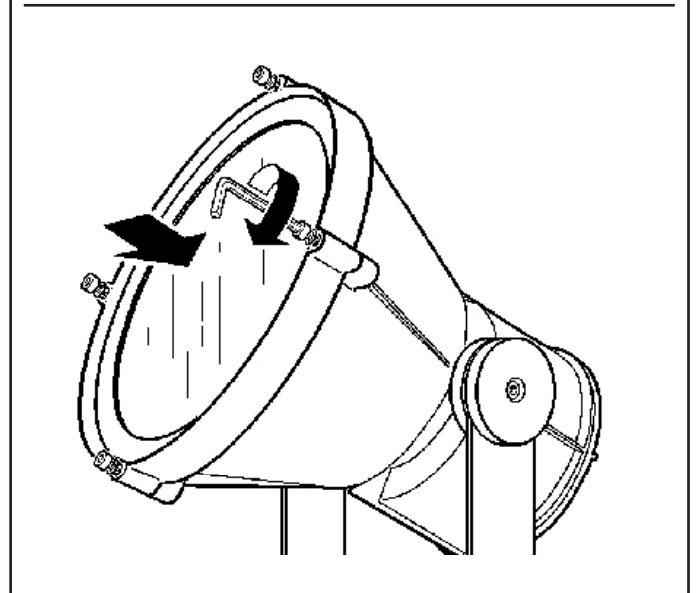
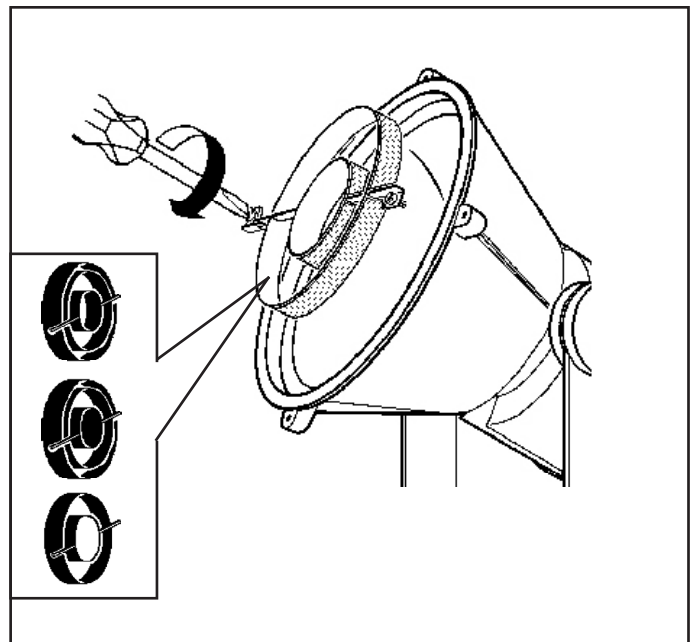
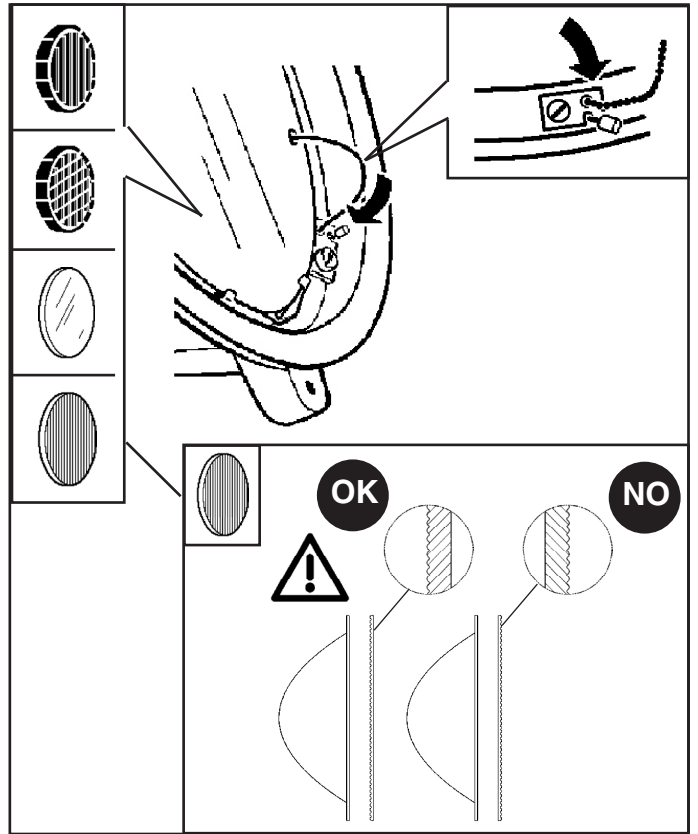
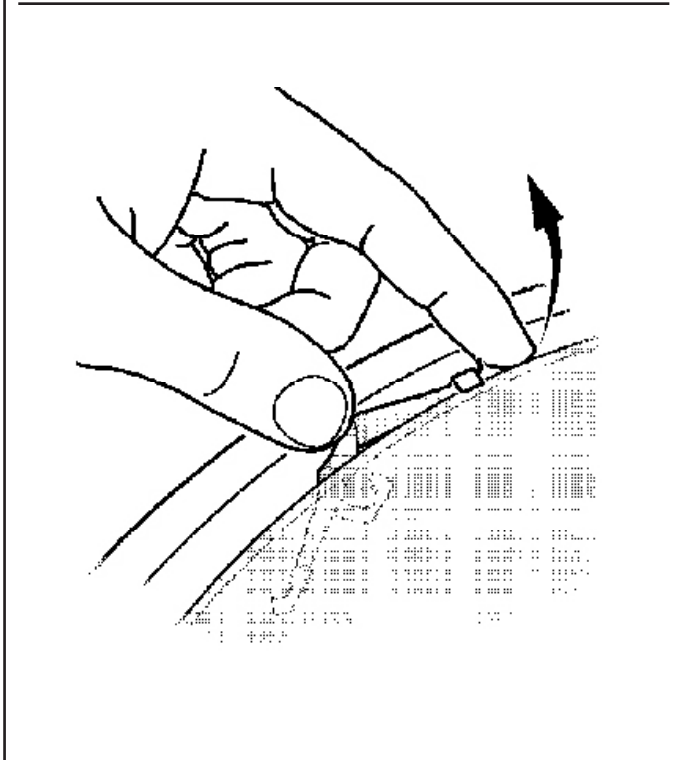
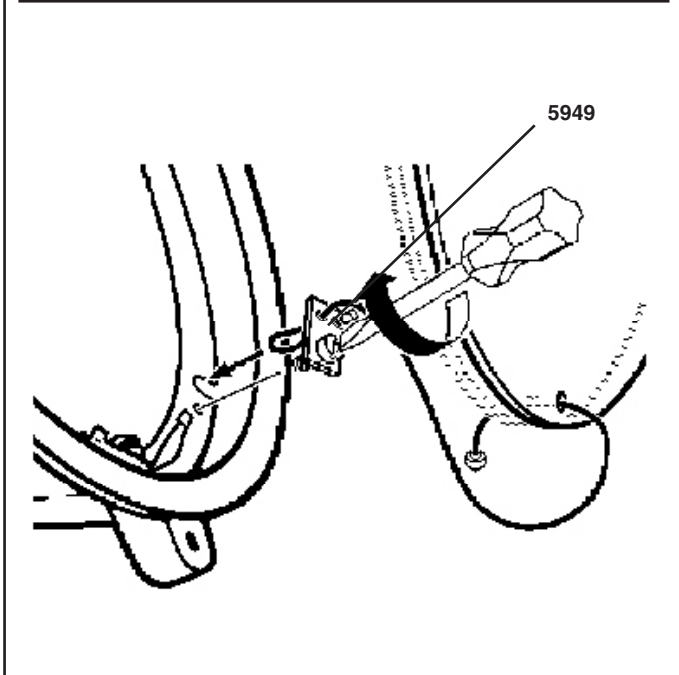
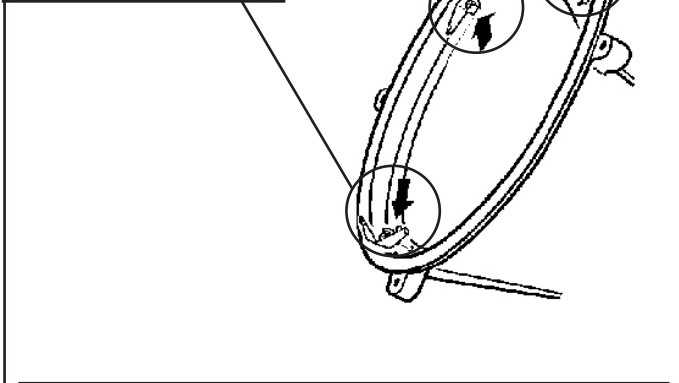
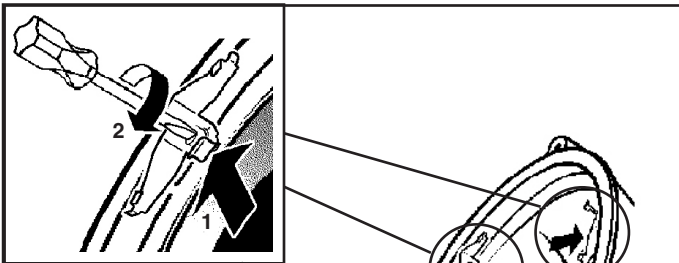

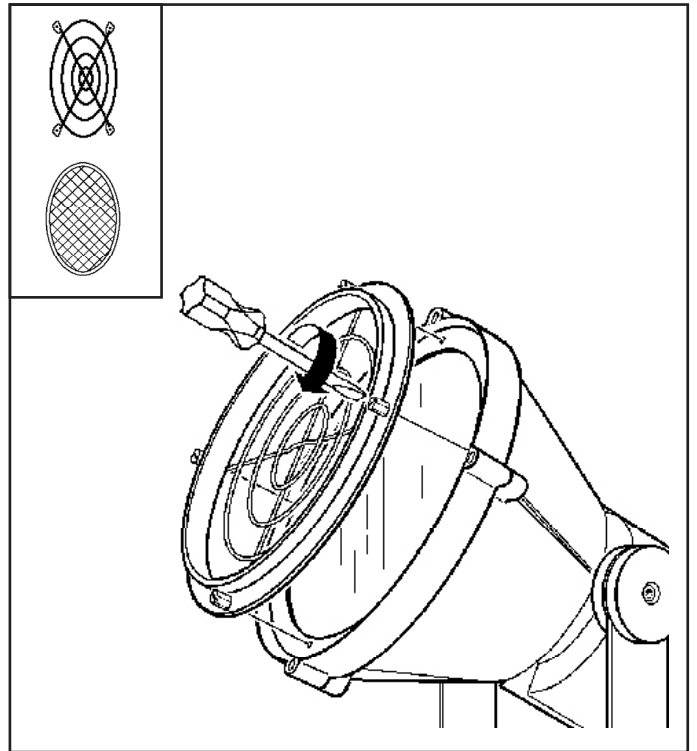
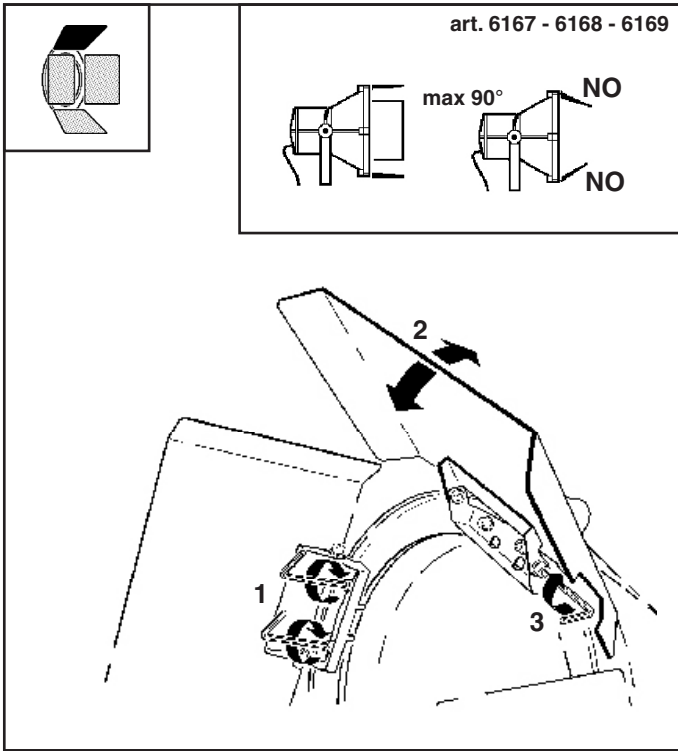

INSTALLAZIONE E REGOLAZIONE DELLO SCHERMO FRANGILUCE
 LOUVER SCREEN INSTALLATION AND ADJUSTMENT
 INSTALLATION ET RÉGLAGE DE LA GRILLE DE DÉFILEMENT
 INSTALLATION UND EINSTELLUNG DES BLENDSCHUTZSCHIRMS
 INSTALLATIE EN AFSTELLING VAN HET LAMELLENSCHERM
 INSTALACIÓN Y REGULACIÓN DE LA PANTALLA ANTIDESLUMBRANTE.
 INSTALLATION OG REGULERING AF LYSSPREDESKÆRMEN
 INSTALLASJON OG JUSTERING AV LYSDELESKJERMEN
 INSTALLATION OCH REGLERING AV LJUSSKÄRMEN
 МОНТАЖ И РЕГУЛЯЦИЯ ЭКРАНА ДИФФУЗОРА
 百叶屏安装和调整

