

## ILS - ORGANIC RESPONSE Sensor Node



**App**  
"Organic Response Express"  
app (Bluetooth)



Download on the  
App Store

GET IT ON



Google Play





**App**  
"Organic Response Express"  
app (Bluetooth)



<https://qrco.de/bcsGF9>



**Organic Response GATEWAY**  
art. X685





**MANUAL USE**



---



**App**  
"Organic Response"  
(Infrared with Dongle, for cloud  
solution/istallation with gateway)



**Dongle**  
art. X687





**App**  
"Organic response Express"



<https://qrco.de/bcsGCA>

### OVERVIEW

Sensor Nodes and their communications form the foundation of the Distributed Intelligence which lies at the heart of the Organic Response System. Each Sensor Node has a motion detector, ambient light sensor, infrared transceiver and an RF transceiver. Ideally (and typically) Sensor Nodes are integrated into each luminaire.

Sensor Nodes control the light output of their associated luminaire using a DALI two wire connection to the Luminaire Driver. Light output is based on a combination of information the Sensor Node collects from its environment, and information it receives from neighboring Sensor Nodes, Wall Switches, smartphones or other devices connected via the OR IoT Gateway. Sensor Nodes have numerous configurable parameters, including, but not limited to:

- Max Light Level
- Personality
- Dwell Time
- Daylight Dimming
- Scenes
- Zones

Further information on the configuration and use of these parameters can be found in the Organic Response user guide at [iguzzini.com](http://iguzzini.com) or directly contact iGuzzini.

### TECHNICAL DATA

<b>DIMMING</b>	Logarithmic. Note: The DALI driver must be configured for logarithmic dimming function.
<b>NODE TO NODE COMMUNICATION PROTOCOL - CONTROL</b>	Organic Response - Wireless infrared
<b>NODE TO NODE COMMUNICATION PROTOCOL - DATA</b>	Wirepas – Wireless RF
<b>RF FREQUENCY BAND</b>	2.4 GHz
<b>RF RANGE - NODE TO NODE</b>	8m max – non Line Of Sight (wireless link operating mode)
<b>RF OPERATIONAL PERFORMANCE</b>	Ability to operate in an office environment with performance unaffected by surrounding structures, walls, ceilings, enclosures and by other RF devices which may be present.
<b>PRODUCT ENVIRONMENT FOR USE</b>	Indoor areas, with recommended ceiling height from 2.7m to 3.7m

1

## MOTION SENSOR

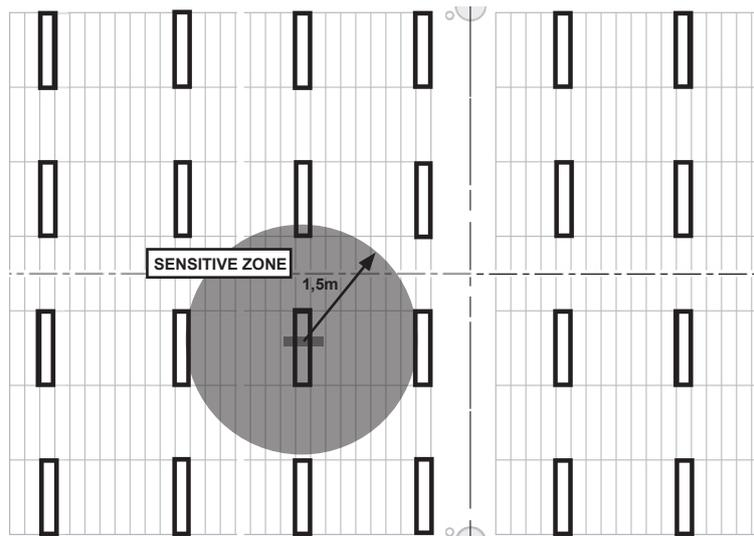

Detection Range of a single Sensor Node imposed over a Typical Office Layout.  
(1.5m circular radius, 2.7m luminaire height)

## KEEPING THE OIC CONTIGUOUS

Organic Response Sensor Nodes communicate with each other wirelessly to form a smart sensor network which we call the Occupancy Information Cloud (OIC)™. The system relies on peer to peer communication between neighboring Sensor Nodes to maintain the integrity of the OIC and allow the light fittings to operate as a system. For this reason, nodes must be installed with the spacing indicated below:

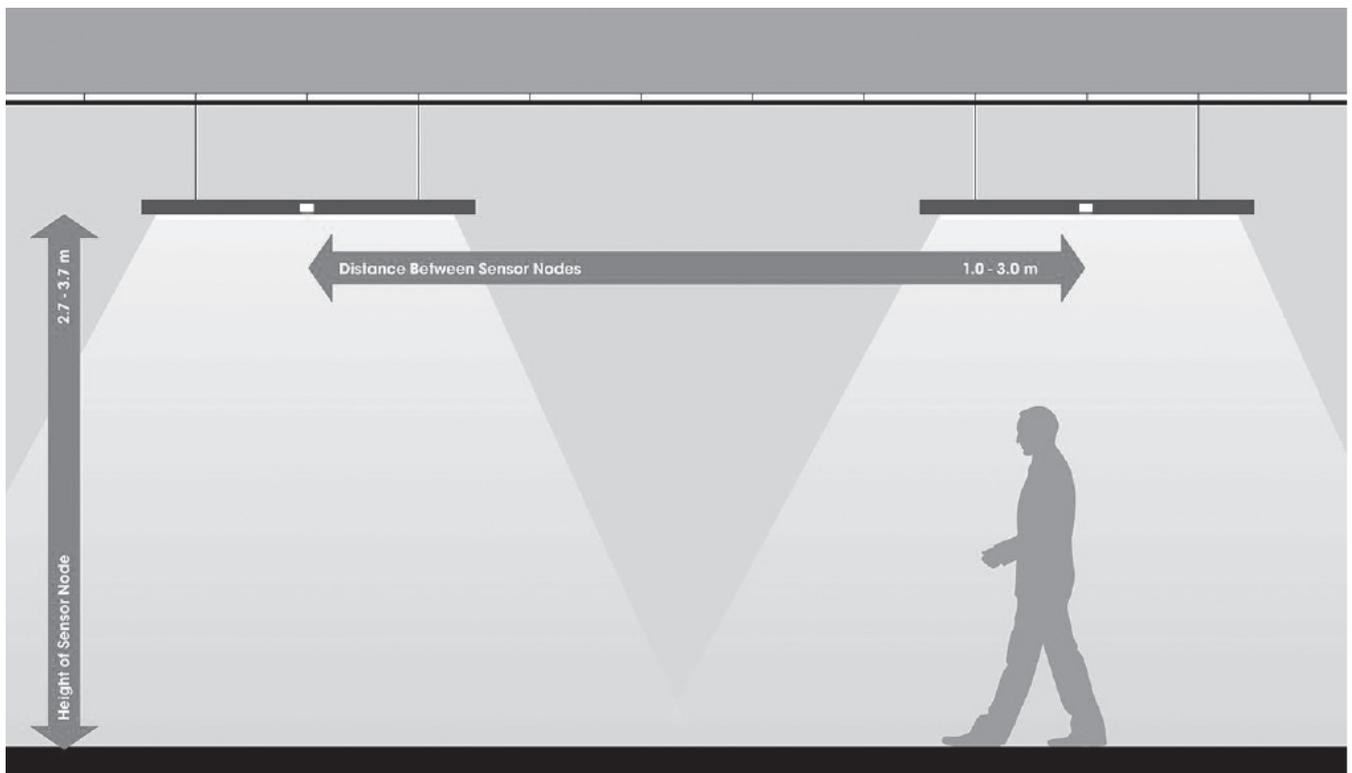

Recommended mounting height and neighbour spacing.  
For height - spacing other than those indicated, please contact iGuzzini.

Organic Response GATEWAY  
art. X685

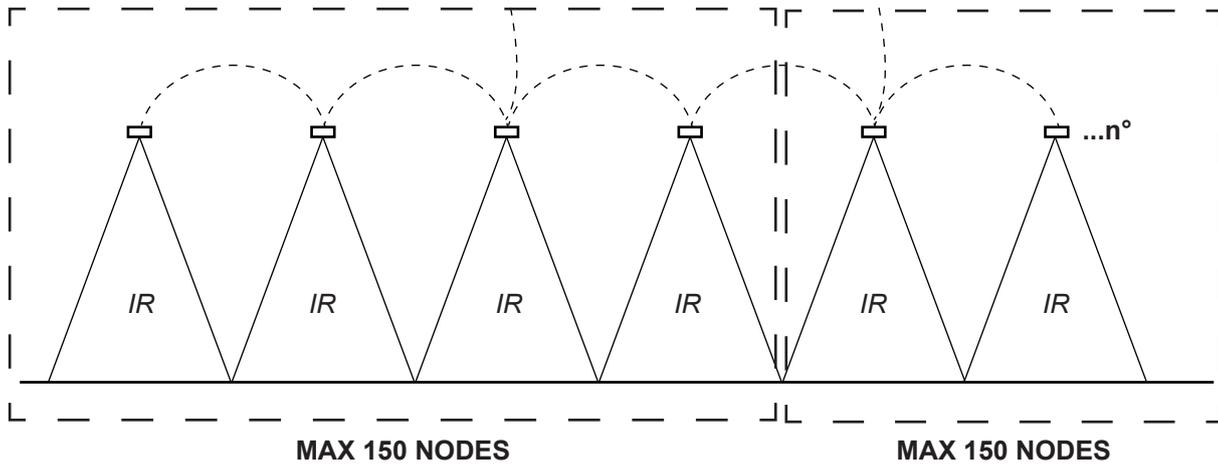
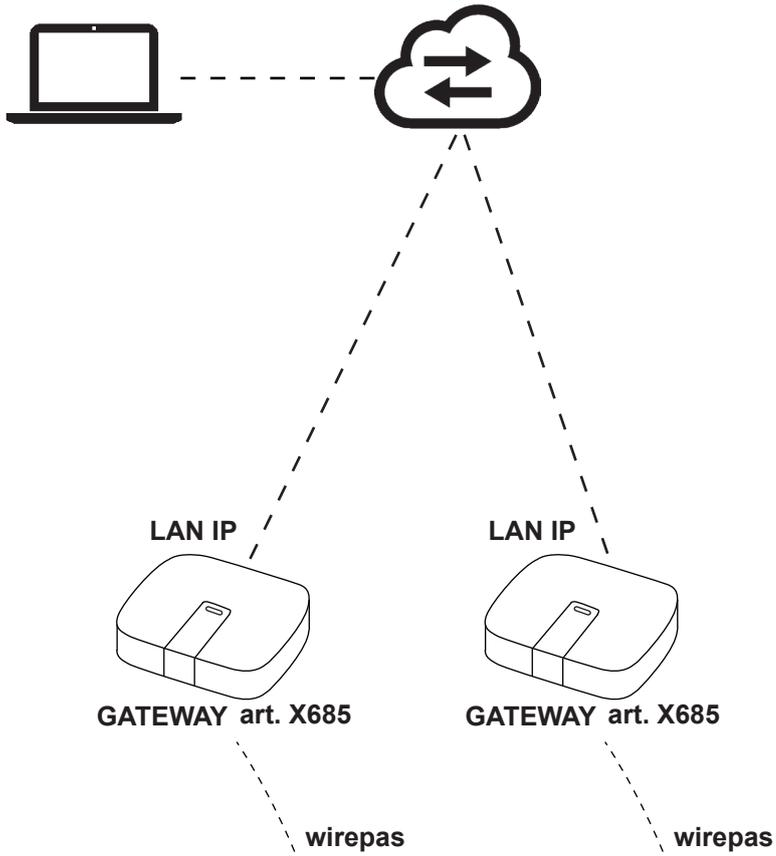

## SPACEPAD L=886mm

### (CASAMBI)

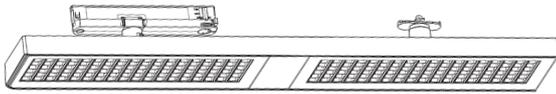
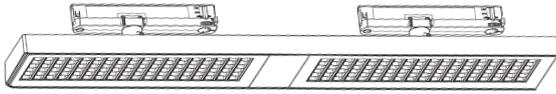

### (DALI)

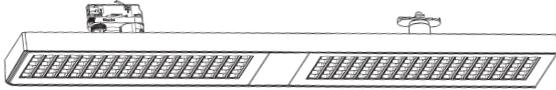

### (DALI-2)

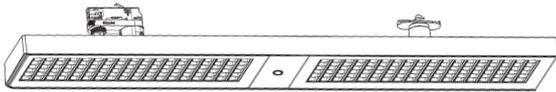

### (ORGANIC RESPONSE)



### IT **Attenzione:**

La sicurezza dell'apparecchio e' garantita solo con l'uso appropriato delle seguenti istruzioni; pertanto e' necessario conservarle.

### EN **Warning:**

The safety of this fixture is guaranteed only if you comply with these instructions; remember to conserve in a safe place.

### FR **Attention:**

La sécurité de l'appareil n'est garantie qu'en cas d'utilisation correcte des instructions suivantes; il faut par conséquent les conserver.

### DE **Achtung:**

Die Sicherheit des gerätes wird nur durch sachgemäße befolgung nachstehender anweisungen gewährleistet; ihre aufbewahrung ist deshalb sehr wichtig.

### NL **Opgelet:**

De veiligheid van di toestel is slechts dan gegarandeerd als indien de volgende instructies strikt worden toegepast; daarom moet men ze ook bewaren.

### ES **Atencion:**

La seguridad del aparato se garantiza solo cumpliendo cuidadosamente las siguientes instrucciones; por ello, es necesario conservarlas.

### DA **Bemærk:**

Sikkerheden ved brug af armaturet kan kun garanteres, hvis disse anvisninger følges; sørg derfor for at gemme dem.

### NO **Advarsel:**

Sikkerheten til dette apparatet garanteres kun hvis du overholder disse instruksjonene; husk å oppbevare dem på et trygt sted.

### SV **Observera:**

Utströmmingens säkerhet kan endast garanteras om dessa anvisningar respekteras i detalj. Spara därför dessa anvisningar för framtida konsultation.

### RU **Внимание:**

Мы гарантируем безопасную эксплуатацию изделия только при соблюдении следующих инструкций; с этой целью необходимо сохранить данную брошюру.

### ZH **警告:**

为确保该装置安全，请遵守操作指示；并于安全场所放置。

### AR

لا يمكن ضمان سلامة هذا الجهاز إلا إذا التزمت بهذه التعليمات. يجب حفظها في مكان آمن.

### تحذير:

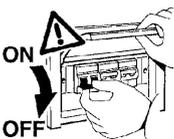

- IT N.B.: Durante l'installazione del sistema rispettare scrupolosamente le norme impiantistiche vigenti.
- EN N.B.: When installing the system, strictly comply with all regulations on installation in force.
- FR N.B.: Lors de l'installation du système veuillez respecter rigoureusement les normes en vigueur en la matière.
- DE N.B.: Beachten sie bei der installation des systems gewissenhaft die gültigen bestimmungen bezüglich der anlagentechnik.
- NL N.B.: Bij het installeren van het systeem moet u de geldende installatienormen strikt naleven.
- ES N.B.: Durante la instalación del sistema respetar e scrupulosamente las normas de instalación vigentes.
- DA N.B.: Under installation af systemet skal man nøje overholde de gældende regler for disse anlæg.
- NO N.B.: Ved installasjon av systemet skal alle forskrifter om installasjon som gjelder følges strengt.
- SV OBS.: Under installationen av systemet ska installationsföreskrifterna respekteras i detalj.
- RU примечание: в процессе монтажа системы строго соблюдайте национальные действующие нормативы по электропроводке.
- ZH 注意: 在安装系统时请遵守设备的安装规定。
- AR ملاحظة: أثناء تركيب النظام يجب التقيد بحرص بالنظم السائدة المتعلقة بالشبكة الكهربائية.

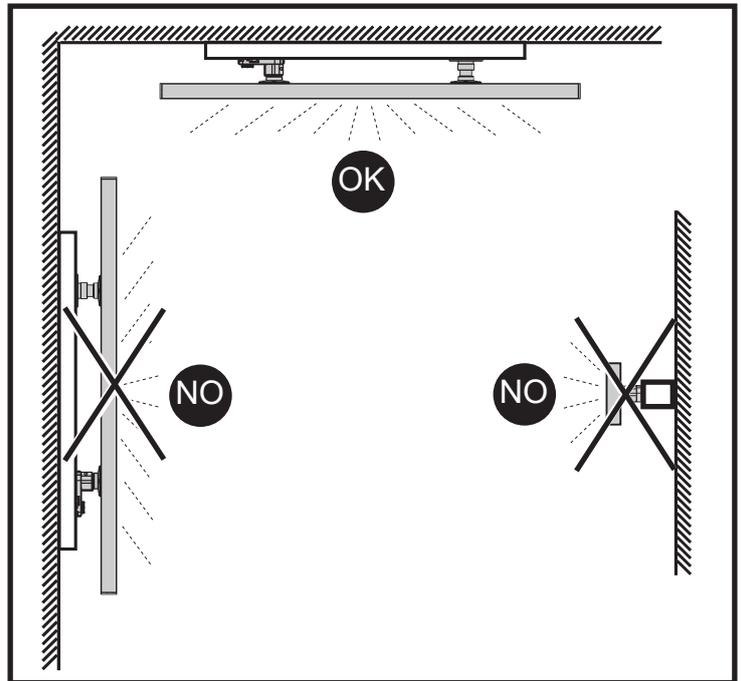

IT Per le posizioni di installazione, attenersi a quelle illustrate, eventualmente contattare la iGuzzini.

EN All installation positions must comply with those illustrated. In the event of any doubt, contact iGuzzini.

FR Pour les positions d'installation, se conformer aux positions illustrées; contacter la société iGuzzini en cas de nécessité.

DE Für die Einbaupositionen die Abbildungen beachten. Eventuell iGuzzini kontaktieren.

NL Houd u voor de installatieposities aan degene die zijn weergegeven. Neem eventueel contact op met iGuzzini.

ES Respetar las posiciones de instalación ilustradas y, en caso de duda, contactar con iGuzzini.

DA For installationspositioner skal man holde sig til de viste, og eventuelt kontakte iGuzzini.

NO For installasjonsposisjonene henviser vi til illustrasjonene, eller ta eventuelt kontakt med iGuzzini.

SV Följ de angivna positionerna för installationen. Kontakta vid behov iGuzzini.

RU При выборе положения для монтажа следует обратиться к проиллюстрированным либо обратиться в компанию iGuzzini.

ZH 安装位置请参考图示，必要时也可联系iGuzzini。

AR في ما يتعلق بأوضاع التركيب، التزم بما هو موضح ومحدد، إذا دعت الضرورة اتصل ب iGuzzini

IT Il funzionamento dei prodotti è garantito solo con l'utilizzo di binari ed accessori iGuzzini

EN Correct product operation is only guaranteed if iGuzzini tracks and accessories are used.

FR Le fonctionnement des produits n'est garanti qu'en cas d'utilisation de rails et accessoires iGuzzini

DE Die Funktion der Produkte ist nur mit dem Einsatz von Schienen und Zubehör iGuzzini gewährleistet

NL De werking van de producten wordt alleen gegarandeerd bij het gebruik van

iGuzzini rails en accessoires.

ES El funcionamiento de los productos se garantiza solamente si se utilizan railes y accesorios iGuzzini.

DA Produktet er kun garanteret med brug af iGuzzini-skiner og -udstyr.

NO Produktenes korrekte drift garanteres bare ved bruk av spor og tilbehør fra iGuzzini

SV Produkternas funktion garanteras endast vid användning av spår och tillbehör från iGuzzini

RU Функционирование продуктов гарантировано только при использовании бинариев и аксессуаров iGuzzini

ZH 此产品的正常运行只有在使用IGUZZINI的轨道及配件的情况下才可以保证

AR بضمن عمل المنتجات فقط من خلال استعمال سكة ومعدات من نوع iGuzzini

## DALI VERSION

NO

BEFORE 2016

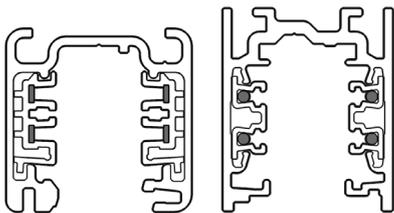

OK

AFTER 2016

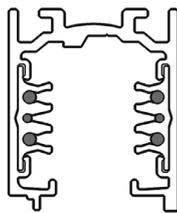

IT Per chiarimenti contattare la "iGuzzini".

EN For more details contact "iGuzzini".

FR Pour plus d'informations contacter « iGuzzini ».

DE Für Detailinformationen wenden Sie sich bitte an „iGuzzini“.

NL Neem contact op met "iGuzzini" voor meer informatie.

ES Para más información contactar con "iGuzzini".

DA Kontakt "iGuzzini" for evt. Afklaringer.

NO Ta kontakt med "iGuzzini" for forklaring.

SV Kontakta "iGuzzini" vid eventuella oklarheter.

RU За разъяснениями обращаться в компанию "iGuzzini".

ZH 如需进一步信息请联系“iGuzzini”。

AR للتوضيح اتصل ب "iGuzzini"

Version:  
- CASAMBI

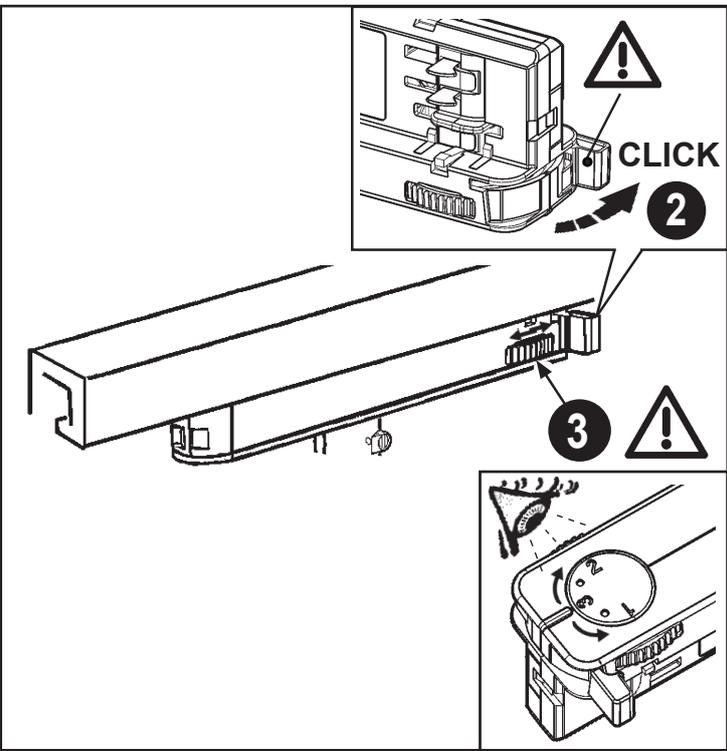
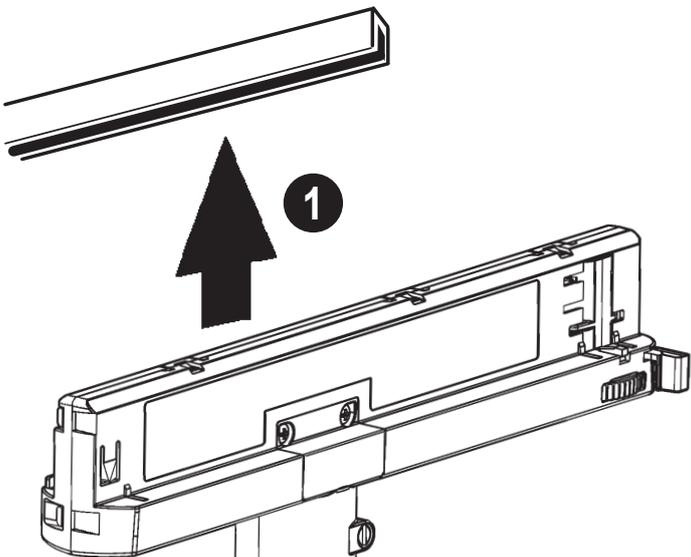

Version:  
- DALI  
- DALI-2  
- ORGANIC RESPONSE

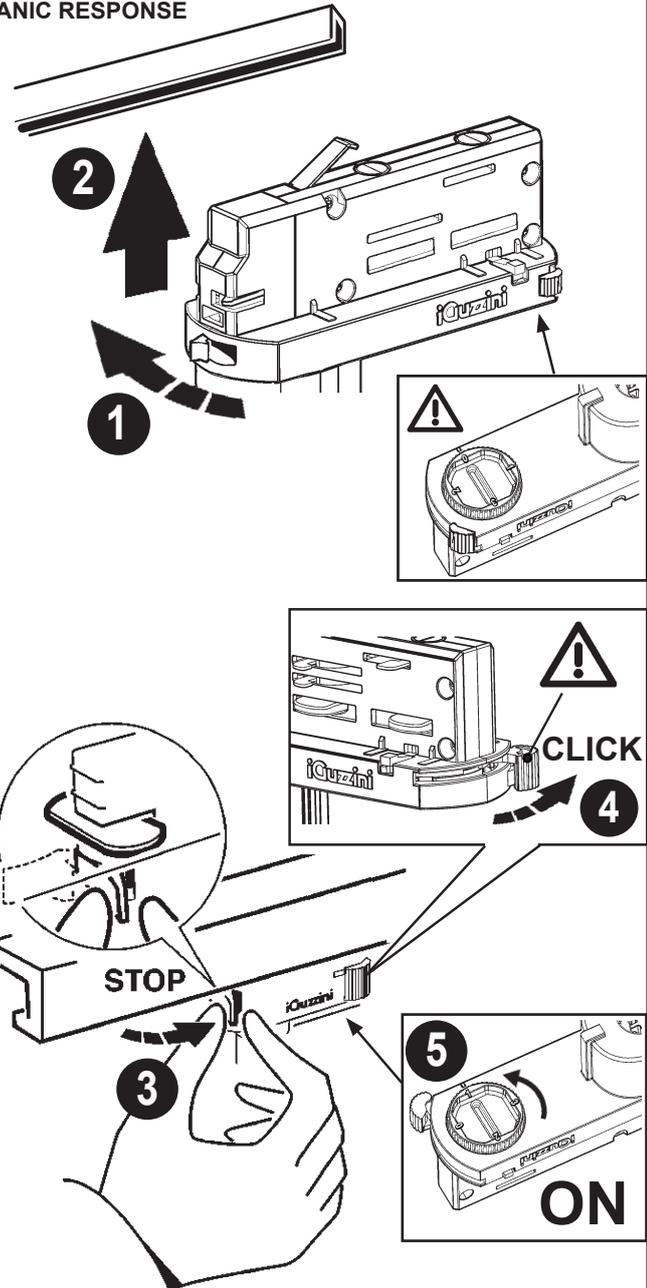

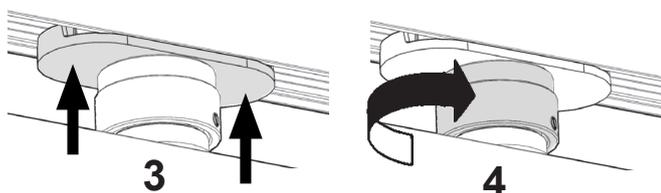
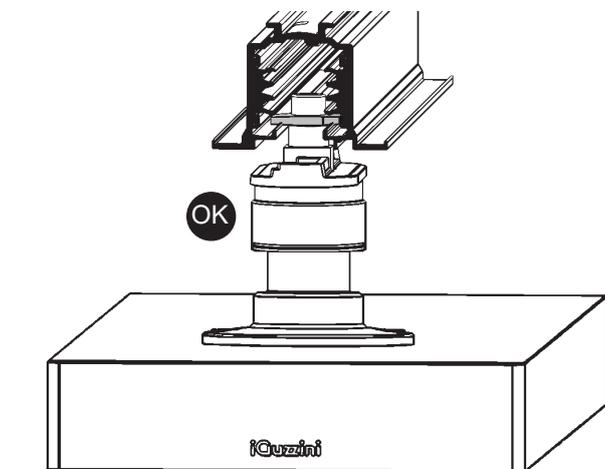
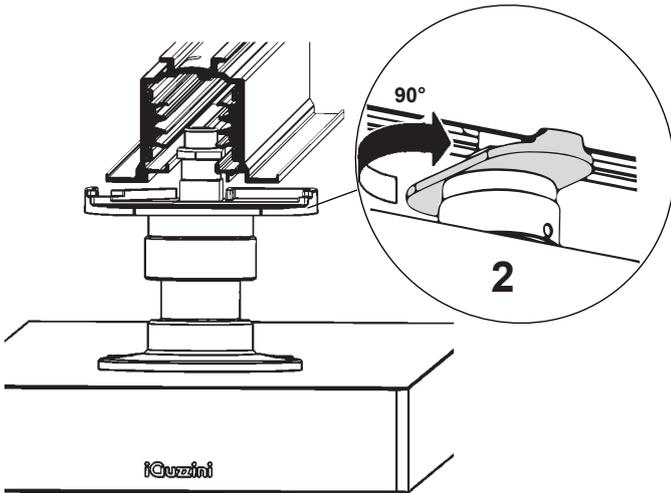
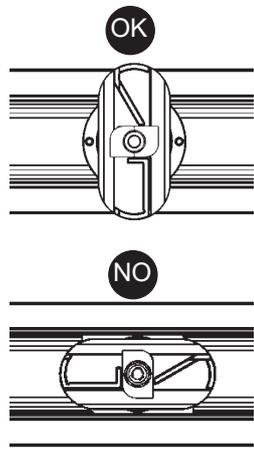
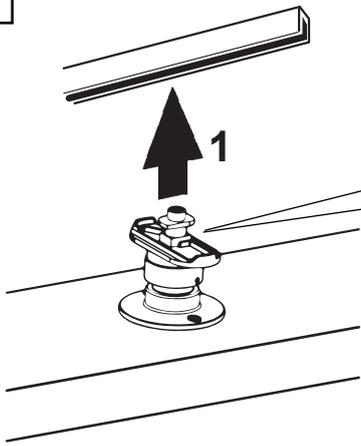

Serrare a fondo  
Tighten firmly  
Serrer à fond  
Fest einrasten  
Goed aanschroeven  
Enroskar en firme  
Skrues i bund  
Trek til godt  
Dra åt till botten  
Закручивать до упора  
完全拧紧  
ثبته بإحكام

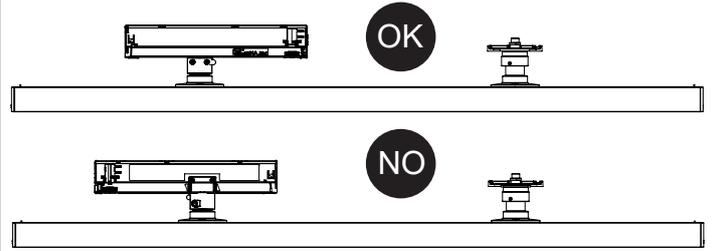
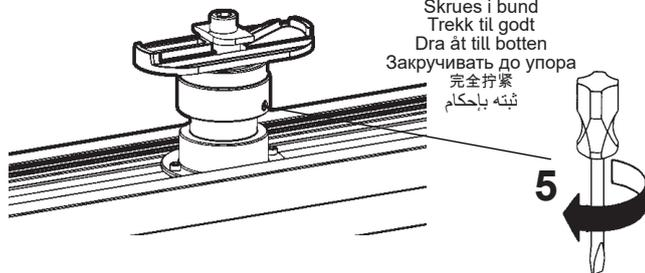

## DISASSEMBLY

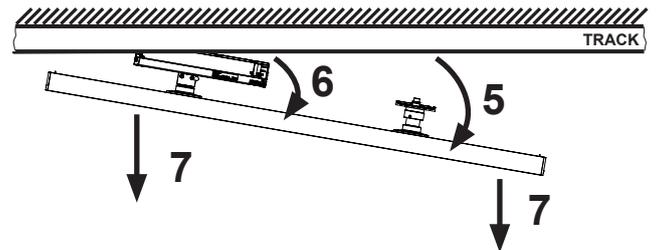
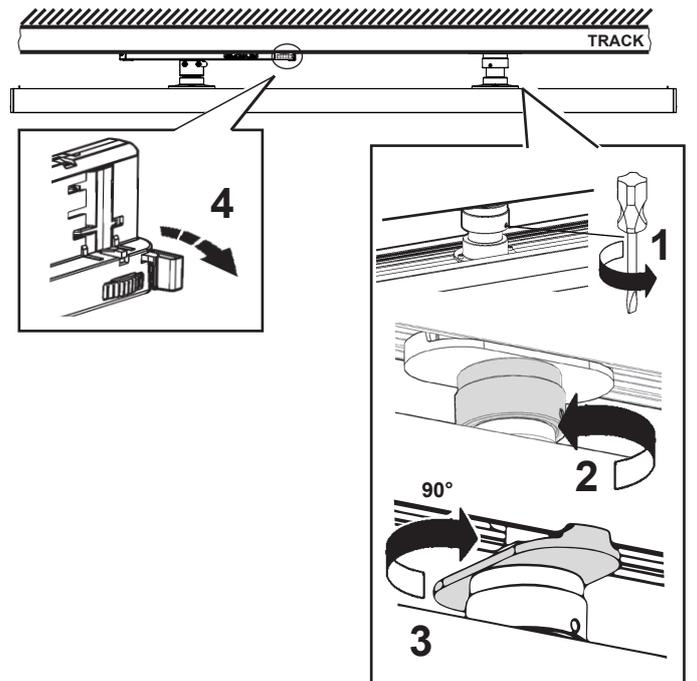

## Version: - DALI

- IT Tra i conduttori di alimentazione e quelli di controllo è garantito un isolamento fondamentale.
- EN Insulation is guaranteed between the power supply wires and the control wires basic.
- FR Entre les conducteurs d'alimentation et les conducteurs de commande, une isolation est garantie fondamentale.
- DE Zwischen den Versorgungs- und Steuerungsleitern ist eine Isolierung Basis gewährleistet.
- NL Tussen de geleiders van de voeding en de controle wordt een isolatie gewaarborgd fundamenteel.
- ES Entre los conductores de alimentación y los de control está garantizado el aislamiento fundamental.
- DA Der er garanteret en isolering grundlæggende imellem forsyningslederne og styrelederne.
- NO Det garanteres en isolering fundamental mellom strømlederne og kontrollederne.
- SV Det garanteras isolering grundläggande mellan matningsledare och kontrollkablar.
- RU Гарантируется развязка цепей питания и управления фундаментальная.
- ZH 电源线和控制线之间有绝缘保证基本。
- AR يتم ضمان العزل بين موصلات التغذية بالطاقة وموصلات التحكم المزوج

<p><b>ART.</b></p>	<p>carico dali / dali load charge dali (courant maxi admissible) dali-last dali vermogen carga dali dali strømstyrke belastning for "dali" dali-belastning макс. ток системы dali с регуляцией интенсивности света DALI 智能调光系统允许的最大 电流量 DALI شحنة / DALI جمل</p>	<p>indirizzi dali dali addresses adresses dali dali-adressen dali adressen direcciones dali dali adresser adresser til "dali" dali-adresser логические адреса системы dali DALI智能调光系统计算机指 定控制参数 DALI عناوين</p>
	<p>1 (2 mA)</p>	<p>1</p>

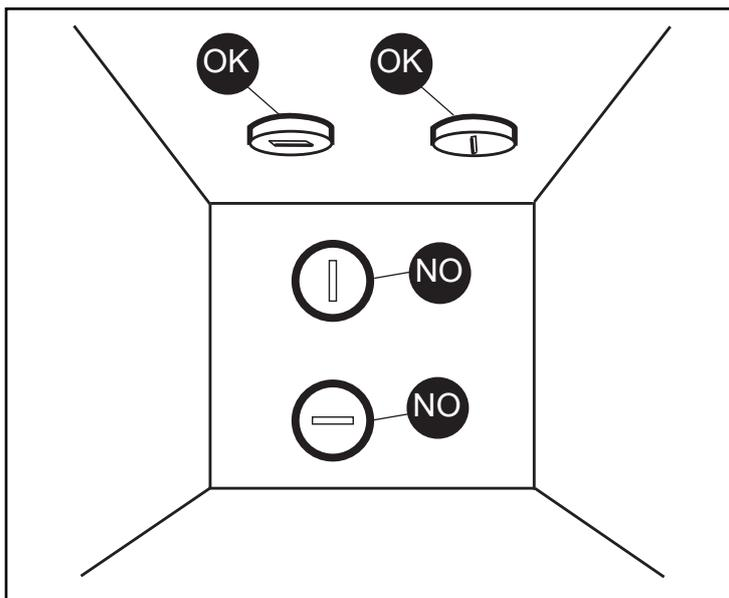
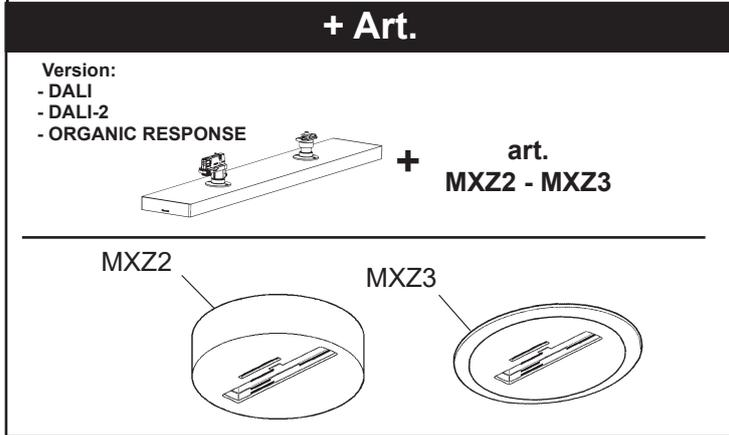
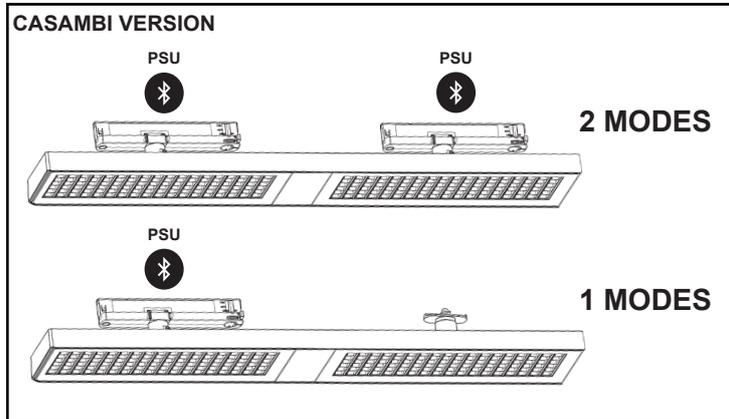

<p><b>IT</b> Per l'installazione con gli accessori art. MXZ2 - MXZ3, fare riferimento al foglio istruzioni relativo.</p> <p><b>EN</b> To install the product with accessories MXZ2 - MXZ3, please see the relevant instruction sheet.</p> <p><b>FR</b> En cas d'installation avec les accessoires art. MXZ2 - MXZ3, se conformer aux instructions de la feuille d'instructions correspondante.</p> <p><b>DE</b> Bezüglich der Installation mit den Zubehörteilen Art. MXZ2 - MXZ3, ziehen Sie das entsprechende Unterweisungsblatt zu Rate.</p> <p><b>NL</b> Voor het installeren van de accessoires art. MXZ2 - MXZ3, kunt u het betreffende instructieblaadje raadplegen.</p> <p><b>ES</b> Para la instalación con los accesorios art. MXZ2 - MXZ3, hágase referencia a la</p>	<p>hoja de instrucciones.</p> <p><b>NO</b> For installation af ekstraudstyr art. MXZ2 - MXZ3, henvises til den pågældende brugsanvisning.</p> <p><b>DA</b> For installation af tilbehøret MXZ2 - MXZ3, vennligst se tilhørende instruksjonsark.</p> <p><b>SV</b> Angående installation med tillbehören MXZ2 - MXZ3, hänvisas till respektive instruktionsblad.</p> <p><b>RU</b> Порядок монтажа аксессуаров art. MXZ2 - MXZ3, смотрите в соответствующих инструкциях.</p> <p><b>ZH</b> 安装配备附件 MXZ2 - MXZ3 的产品时，请参阅相关说明表。</p> <p><b>AR</b> لتثبيت التجهيز بالملحقات MXZ2 - MXZ3 ارجع إلى ورقة التعليمات ذات الصلة.</p>
--	---

<p>hoja de instrucciones.</p> <p><b>NO</b> For installation af ekstraudstyr art. MXZ2 - MXZ3, henvises til den pågældende brugsanvisning.</p> <p><b>DA</b> For installation af tilbehøret MXZ2 - MXZ3, vennligst se tilhørende instruksjonsark.</p> <p><b>SV</b> Angående installation med tillbehören MXZ2 - MXZ3, hänvisas till respektive instruktionsblad.</p> <p><b>RU</b> Порядок монтажа аксессуаров art. MXZ2 - MXZ3, смотрите в соответствующих инструкциях.</p> <p><b>ZH</b> 安装配备附件 MXZ2 - MXZ3 的产品时，请参阅相关说明表。</p> <p><b>AR</b> لتثبيت التجهيز بالملحقات MXZ2 - MXZ3 ارجع إلى ورقة التعليمات ذات الصلة.</p>	<p>hoja de instrucciones.</p> <p><b>NO</b> For installation af ekstraudstyr art. MXZ2 - MXZ3, henvises til den pågældende brugsanvisning.</p> <p><b>DA</b> For installation af tilbehøret MXZ2 - MXZ3, vennligst se tilhørende instruksjonsark.</p> <p><b>SV</b> Angående installation med tillbehören MXZ2 - MXZ3, hänvisas till respektive instruktionsblad.</p> <p><b>RU</b> Порядок монтажа аксессуаров art. MXZ2 - MXZ3, смотрите в соответствующих инструкциях.</p> <p><b>ZH</b> 安装配备附件 MXZ2 - MXZ3 的产品时，请参阅相关说明表。</p> <p><b>AR</b> لتثبيت التجهيز بالملحقات MXZ2 - MXZ3 ارجع إلى ورقة التعليمات ذات الصلة.</p>
---	---

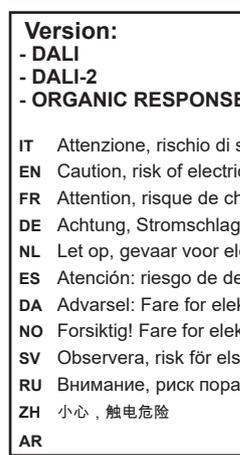
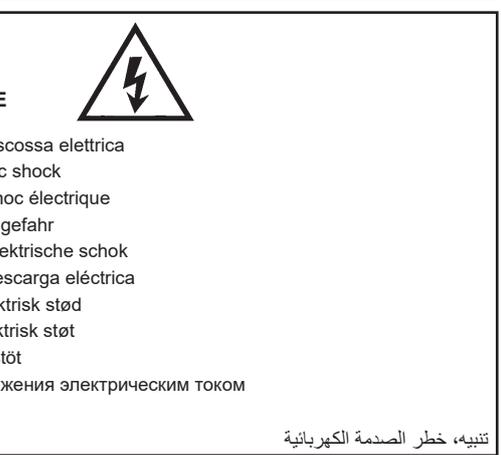

<p><b>IT</b> N.B.: Per la sostituzione del LED contattare l'azienda iGuzzini.</p> <p><b>EN</b> N.B.: For information on LED replacement please contact iGuzzini.</p> <p><b>FR</b> N.B.: Pour procéder au remplacement de la LED, adressez-vous à la société iGuzzini.</p> <p><b>DE</b> N.B.: Bezüglich des Austausches der LED kontaktieren Sie bitte die Firma iGuzzini.</p> <p><b>NL</b> N.B.: Voor het vervangen van de LED neemt u contact op met het bedrijf iGuzzini.</p> <p><b>ES</b> NOTA: Para sustituir el LED llame a la empresa iGuzzini.</p> <p><b>DA</b> N.B.: For udskiftning af lysdioden, skal man kontakte iGuzzini.</p> <p><b>NO</b> N.B.: For informasjon om skifte av LED, vennligst ta kontakt med iGuzzini.</p> <p><b>SV</b> OBS! För byte av lysdioden, kontakta företaget iGuzzini.</p> <p><b>RU</b> ПРИМЕЧАНИЕ: Для замены СИДов обращайтесь в компанию iGuzzini.</p> <p><b>ZH</b> 注意：如需LED更换的信息，请联系iGuzzini</p> <p><b>AR</b> تنبيه: لاستبدال الضوء LED اتصل بشركة iGuzzini</p>	<p><b>IT</b> N.B.: Per la sostituzione del LED contattare l'azienda iGuzzini.</p> <p><b>EN</b> N.B.: For information on LED replacement please contact iGuzzini.</p> <p><b>FR</b> N.B.: Pour procéder au remplacement de la LED, adressez-vous à la société iGuzzini.</p> <p><b>DE</b> N.B.: Bezüglich des Austausches der LED kontaktieren Sie bitte die Firma iGuzzini.</p> <p><b>NL</b> N.B.: Voor het vervangen van de LED neemt u contact op met het bedrijf iGuzzini.</p> <p><b>ES</b> NOTA: Para sustituir el LED llame a la empresa iGuzzini.</p> <p><b>DA</b> N.B.: For udskiftning af lysdioden, skal man kontakte iGuzzini.</p> <p><b>NO</b> N.B.: For informasjon om skifte av LED, vennligst ta kontakt med iGuzzini.</p> <p><b>SV</b> OBS! För byte av lysdioden, kontakta företaget iGuzzini.</p> <p><b>RU</b> ПРИМЕЧАНИЕ: Для замены СИДов обращайтесь в компанию iGuzzini.</p> <p><b>ZH</b> 注意：如需LED更换的信息，请联系iGuzzini</p> <p><b>AR</b> تنبيه: لاستبدال الضوء LED اتصل بشركة iGuzzini</p>
---	---

<p><b>Version:</b> - DALI - DALI-2 - ORGANIC RESPONSE</p>  <p><b>IT</b> Attenzione, rischio di scossa elettrica</p> <p><b>EN</b> Caution, risk of electric shock</p> <p><b>FR</b> Attention, risque de choc électrique</p> <p><b>DE</b> Achtung, Stromschlaggefahr</p> <p><b>NL</b> Let op, gevaar voor elektrische schok</p> <p><b>ES</b> Atención: riesgo de descarga eléctrica</p> <p><b>DA</b> Advarsel: Fare for elektrisk stød</p> <p><b>NO</b> Forsiktig! Fare for elektrisk stød</p> <p><b>SV</b> Observera, risk för elstöt</p> <p><b>RU</b> Внимание, риск поражения электрическим током</p> <p><b>ZH</b> 小心，触电危险</p> <p><b>AR</b> تنبيه، خطر الصدمة الكهربائية</p>	<p><b>Version:</b> - DALI - DALI-2 - ORGANIC RESPONSE</p>  <p><b>IT</b> Attenzione, rischio di scossa elettrica</p> <p><b>EN</b> Caution, risk of electric shock</p> <p><b>FR</b> Attention, risque de choc électrique</p> <p><b>DE</b> Achtung, Stromschlaggefahr</p> <p><b>NL</b> Let op, gevaar voor elektrische schok</p> <p><b>ES</b> Atención: riesgo de descarga eléctrica</p> <p><b>DA</b> Advarsel: Fare for elektrisk stød</p> <p><b>NO</b> Forsiktig! Fare for elektrisk stød</p> <p><b>SV</b> Observera, risk för elstöt</p> <p><b>RU</b> Внимание, риск поражения электрическим током</p> <p><b>ZH</b> 小心，触电危险</p> <p><b>AR</b> تنبيه، خطر الصدمة الكهربائية</p>
--	---

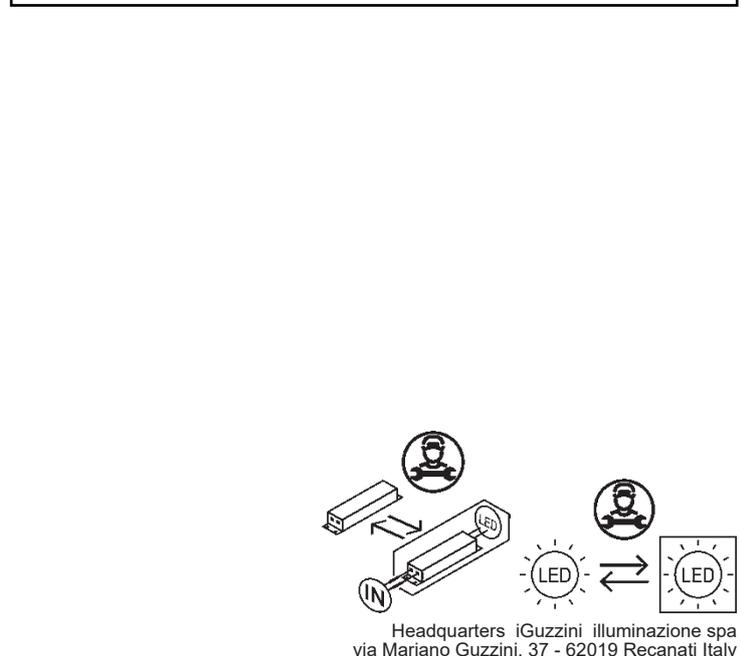
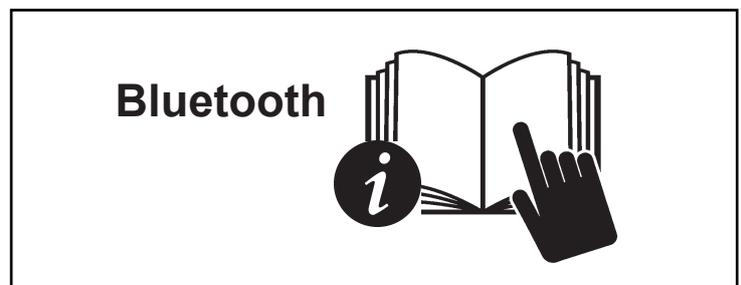

2.510.780.01 IS19974/01		<b>iGuzini</b>		fattore di potenza power factor facteur de puissance Leistungsfaktor vermogensfactor factor de potencia effektfaktor effektfaktor effektfaktor фактор мощности 功率因数 عامل القدرة	corrente assorbita absorbed current courant absorbé Stromaufnahme stroomopname corriente absorbida absorberet strøm absorbert strøm tilford strøm поглощаемая мощность 电源电流 التيار الممتص
<b>ART.</b>		<b>λ</b>	<b>A</b>		
RS69 - RS70 - RS71	.7S1 - .7S2	0,81	0,09		
	.7S3 - .7S4	0,80	0,09		
RS72	.7S1 - .7S2	0,79	0,08		
	.7S3 - .7S4	0,79	0,09		
RS73 - RS74	.7S1 - .7S2	0,85	0,10		
	.7S3 - .7S4	0,85	0,10		
RS75 - RS76	.7S1 - .7S2	0,83	0,10		
	.7S3 - .7S4	0,84	0,10		
RS85 - PZ44 - PZ45 - PZ46 - RT65 - RT66 RT67 - RT68 - PY79 - PY80 - PY81 - PY82 PY87 - PY88 - PY89 - PY90	.7S1 - .7S2	>0,9	0,14		
	.7S3 - .7S4	>0,9	0,15		
RS86 - RS87 - RS88 - PZ51 - PZ52 - PZ53 - PZ54	.7S1 - .7S2	>0,9	0,13		
	.7S3 - .7S4	>0,9	0,14		
RS89 - RS90 - RS91 - PZ50 - PZ55 - PZ56 - PZ57	.7S1 - .7S2	>0,9	0,15		
	.7S3 - .7S4	>0,9	0,17		
RS92 - PZ58	.7S1 - .7S2	>0,9	0,14		
	.7S3 - .7S4	>0,9	0,16		
RS77 - RS78 - RS79 - RS80	.7S1 - .7S2	>0,9	0,08		
	.7S3 - .7S4	>0,95	0,09		
RS81	.7S1 - .7S2	>0,9	0,09		
	.7S3 - .7S4	>0,95	0,10		
RS82	.7S1 - .7S2	>0,95	0,10		
	.7S3 - .7S4	>0,95	0,10		
RS83 - RS84	.7S1 - .7S2	>0,95	0,09		
	.7S3 - .7S4	>0,95	0,10		
RS93	.7S1 - .7S2	>0,95	0,15		
	.7S3 - .7S4	>0,95	0,15		
RS94 - RS95 - RS96	.7S1 - .7S2	>0,95	0,12		
	.7S3 - .7S4	>0,95	0,14		
RS97 - RS98 - RS99	.7S1 - .7S2	>0,95	0,15		
	.7S3 - .7S4	>0,95	0,17		
RT00	.7S1 - .7S2	>0,95	0,14		
	.7S3 - .7S4	>0,95	0,16		
PZ27 - PZ28 - PZ29	.7S1 - .7S2	0,80	0,09		
	.7S3 - .7S4	0,80	0,10		
PZ30	.7S1 - .7S2	0,79	0,09		
	.7S3 - .7S4	0,80	0,10		
PZ31 - PZ32	.7S1 - .7S2	0,83	0,10		
	.7S3 - .7S4	0,86	0,10		
PZ33 - PZ34	.7S1 - .7S2	0,82	0,10		
	.7S3 - .7S4	0,85	0,10		
PZ43	.7S1 - .7S2	>0,9	0,15		
	.7S3 - .7S4	>0,9	0,16		
PZ47 - PZ48 - PZ49	.7S1 - .7S2	>0,9	0,16		
	.7S3 - .7S4	>0,9	0,18		
PZ35 - PZ36 - PZ37	.7S1 - .7S2	0,78	0,08		
	.7S3 - .7S4	0,80	0,09		
PZ38	.7S1 - .7S2	0,76	0,08		
	.7S3 - .7S4	0,80	0,09		
PZ39 - PZ40	.7S1 - .7S2	0,83	0,10		
	.7S3 - .7S4	0,85	0,10		
PZ41 - PZ42	.7S1 - .7S2	0,81	0,09		
	.7S3 - .7S4	0,84	0,10		
RT69 - RT70 - PY83 - PY84 - PY91 - PY92	.7S1 - .7S2	>0,9	0,17		
	.7S3 - .7S4	>0,95	0,19		
RT71 - RT72	.7S1 - .7S2	>0,9	0,15		
	.7S3 - .7S4	>0,9	0,18		
RT81 - PY95	.7S1 - .7S2	>0,95	0,25		
	.7S3 - .7S4	>0,95	0,27		
RT82 - RT83 - RT84	.7S1 - .7S2	>0,95	0,23		
	.7S3 - .7S4	>0,95	0,26		
RT85 - RT86 - PY99 - PZ00 - PZ01	.7S1 - .7S2	>0,95	0,28		
	.7S3 - .7S4	>0,95	0,30		
RT87 - RT93 - RT94	.7S1 - .7S2	>0,95	0,30		
	.7S3 - .7S4	>0,95	0,30		
RT88 - PZ02	.7S1 - .7S2	>0,95	0,26		
	.7S3 - .7S4	>0,95	0,30		
RT73 - RT74 - RT75 - RT76	.7S1 - .7S2	>0,95	0,30		
	.7S3 - .7S4	>0,95	0,34		
RT77 - RT78 - RT79 - RT80	.7S1 - .7S2	>0,95	0,33		
	.7S3 - .7S4	>0,95	0,38		
RT89	.7S1 - .7S2	>0,95	0,26		
	.7S3 - .7S4	>0,95	0,28		
RT90 - RT91 - RT92	.7S1 - .7S2	>0,95	0,24		
	.7S3 - .7S4	>0,95	0,27		
RT95 - RT96	.7S1 - .7S2	>0,95	0,28		
	.7S3 - .7S4	>0,95	0,32		
PY85 - PY86 - PY93 - PY94	.7S1 - .7S2	>0,9	0,16		
	.7S3 - .7S4	>0,95	0,18		
PY96 - PY97 - PY98	.7S1 - .7S2	>0,95	0,24		
	.7S3 - .7S4	>0,95	0,26		

2.510.780.01 IS19974/01		<b>iGuzini</b>		fattore di potenza power factor facteur de puissance Leistungsfaktor vermogensfactor factor de potencia effektfaktor effektfaktor effektfaktor фактор мощности 功率因数 عامل القدرة	corrente assorbita absorbed current courant absorbé Stromaufnahme stroomopname corriente absorbida absorberet strøm absorbert strøm tilford strøm поглощаемая мощность 电源电流 التيار الممتص
<b>ART.</b>		<b>λ</b>	<b>A</b>		
RS69 - RS70 - RS71	.7S1 - .7S2	0,81	0,09		
	.7S3 - .7S4	0,80	0,09		
RS72	.7S1 - .7S2	0,79	0,08		
	.7S3 - .7S4	0,79	0,09		
RS73 - RS74	.7S1 - .7S2	0,85	0,10		
	.7S3 - .7S4	0,85	0,10		
RS75 - RS76	.7S1 - .7S2	0,83	0,10		
	.7S3 - .7S4	0,84	0,10		
RS85 - PZ44 - PZ45 - PZ46 - RT65 - RT66 RT67 - RT68 - PY79 - PY80 - PY81 - PY82 PY87 - PY88 - PY89 - PY90	.7S1 - .7S2	>0,9	0,14		
	.7S3 - .7S4	>0,9	0,15		
RS86 - RS87 - RS88 - PZ51 - PZ52 - PZ53 - PZ54	.7S1 - .7S2	>0,9	0,13		
	.7S3 - .7S4	>0,9	0,14		
RS89 - RS90 - RS91 - PZ50 - PZ55 - PZ56 - PZ57	.7S1 - .7S2	>0,9	0,15		
	.7S3 - .7S4	>0,9	0,17		
RS92 - PZ58	.7S1 - .7S2	>0,9	0,14		
	.7S3 - .7S4	>0,9	0,16		
RS77 - RS78 - RS79 - RS80	.7S1 - .7S2	>0,9	0,08		
	.7S3 - .7S4	>0,95	0,09		
RS81	.7S1 - .7S2	>0,9	0,09		
	.7S3 - .7S4	>0,95	0,10		
RS82	.7S1 - .7S2	>0,95	0,10		
	.7S3 - .7S4	>0,95	0,10		
RS83 - RS84	.7S1 - .7S2	>0,95	0,09		
	.7S3 - .7S4	>0,95	0,10		
RS93	.7S1 - .7S2	>0,95	0,15		
	.7S3 - .7S4	>0,95	0,15		
RS94 - RS95 - RS96	.7S1 - .7S2	>0,95	0,12		
	.7S3 - .7S4	>0,95	0,14		
RS97 - RS98 - RS99	.7S1 - .7S2	>0,95	0,15		
	.7S3 - .7S4	>0,95	0,17		
RT00	.7S1 - .7S2	>0,95	0,14		
	.7S3 - .7S4	>0,95	0,16		
PZ27 - PZ28 - PZ29	.7S1 - .7S2	0,80	0,09		
	.7S3 - .7S4	0,80	0,10		
PZ30	.7S1 - .7S2	0,79	0,09		
	.7S3 - .7S4	0,80	0,10		
PZ31 - PZ32	.7S1 - .7S2	0,83	0,10		
	.7S3 - .7S4	0,86	0,10		
PZ33 - PZ34	.7S1 - .7S2	0,82	0,10		
	.7S3 - .7S4	0,85	0,10		
PZ43	.7S1 - .7S2	>0,9	0,15		
	.7S3 - .7S4	>0,9	0,16		
PZ47 - PZ48 - PZ49	.7S1 - .7S2	>0,9	0,16		
	.7S3 - .7S4	>0,9	0,18		
PZ35 - PZ36 - PZ37	.7S1 - .7S2	0,78	0,08		
	.7S3 - .7S4	0,80	0,09		
PZ38	.7S1 - .7S2	0,76	0,08		
	.7S3 - .7S4	0,80	0,09		
PZ39 - PZ40	.7S1 - .7S2	0,83	0,10		
	.7S3 - .7S4	0,85	0,10		
PZ41 - PZ42	.7S1 - .7S2	0,81	0,09		
	.7S3 - .7S4	0,84	0,10		
RT69 - RT70 - PY83 - PY84 - PY91 - PY92	.7S1 - .7S2	>0,9	0,17		
	.7S3 - .7S4	>0,95	0,19		
RT71 - RT72	.7S1 - .7S2	>0,9	0,15		
	.7S3 - .7S4	>0,9	0,18		
RT81 - PY95	.7S1 - .7S2	>0,95	0,25		
	.7S3 - .7S4	>0,95	0,27		
RT82 - RT83 - RT84	.7S1 - .7S2	>0,95	0,23		
	.7S3 - .7S4	>0,95	0,26		
RT85 - RT86 - PY99 - PZ00 - PZ01	.7S1 - .7S2	>0,95	0,28		
	.7S3 - .7S4	>0,95	0,30		
RT87 - RT93 - RT94	.7S1 - .7S2	>0,95	0,30		
	.7S3 - .7S4	>0,95	0,30		
RT88 - PZ02	.7S1 - .7S2	>0,95	0,26		
	.7S3 - .7S4	>0,95	0,30		
RT73 - RT74 - RT75 - RT76	.7S1 - .7S2	>0,95	0,30		
	.7S3 - .7S4	>0,95	0,34		
RT77 - RT78 - RT79 - RT80	.7S1 - .7S2	>0,95	0,33		
	.7S3 - .7S4	>0,95	0,38		
RT89	.7S1 - .7S2	>0,95	0,26		
	.7S3 - .7S4	>0,95	0,28		
RT90 - RT91 - RT92	.7S1 - .7S2	>0,95	0,24		
	.7S3 - .7S4	>0,95	0,27		
RT95 - RT96	.7S1 - .7S2	>0,95	0,28		
	.7S3 - .7S4	>0,95	0,32		
PY85 - PY86 - PY93 - PY94	.7S1 - .7S2	>0,9	0,16		
	.7S3 - .7S4	>0,95	0,18		
PY96 - PY97 - PY98	.7S1 - .7S2	>0,95	0,24		
	.7S3 - .7S4	>0,95	0,26		



- I Istruzioni per le operazioni di servizio per l'apparecchio di illuminazione**  
**GB Instructions on luminaire service operations**  
**F Instructions pour les opérations de service du luminaire**  
**D Wartungsanleitung für die Leuchte**  
**NL Instructies voor de onderhoudsoperaties op de verlichtingsarmatuur**  
**E Instrucciones para las operaciones de servicio del aparato de alumbrado**  
**DK Anvisninger i serviceindgreb på belysningsarmatur**  
**N Anvisninger for betjening av lysapparatet**  
**S Instruktioner för användning av belysningsanordningen**  
**RUS Инструкции по эксплуатации осветительного прибора**  
**CN 照明装置检修操作说明**

**Sostituire la lampada parzialmente esausta**  
 Replace the partly exhausted lamp  
 Remplacer la lampe partiellement épuisée  
 Die teilweise erschöpfte Lampe austauschen  
 Vervang de gedeeltelijk lege lamp  
 Sustituir la lámpara parcialmente agotada  
 Udskift den delvist udtjente pære  
 Skifte ut den delvis utbrænte lyspæren  
 Byt ut den delvis förbrukade lampan  
 Замена частично отработанной лампочки  
 更换部分老化的灯泡

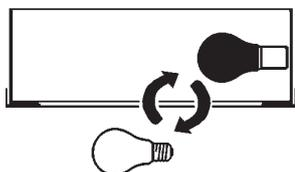

**Spegnimento**  
 Switch it off  
 Extinction  
 Ausschaltung  
 Uitschakeling  
 Apagado  
 Slukning  
 Slukking  
 Släckning  
 Выключение  
 关灯

**Interrompere l'alimentazione dell'apparecchio**  
 Cut the power supply to the luminaire  
 Couper l'alimentation du luminaire  
 Stromversorgung der Leuchte unterbrechen  
 Onderbreek de voeding van het apparaat  
 Interrumpir la alimentación del aparato  
 Afbryd armaturets strømforsyning  
 Avbryt strømtilførselen til apparatet  
 Koppla från anordningens strömförsörjning  
 Отключить электропитание прибора  
 中断装置供电

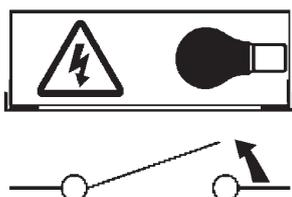

**Aprire l'apparecchio**  
 Open the fixture  
 Ouvrir le luminaire  
 Das Gerät öffnen  
 Open het apparaat  
 Abrir el aparato  
 Åbn armaturet  
 Åpne apparatet  
 Öppna anordningen  
 Раскрыть прибор  
 打开装置

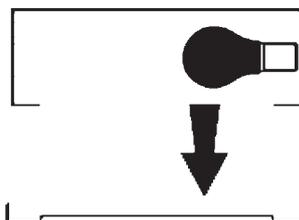

**Rimuovere la lampada esausta**  
 Remove the exhausted lamp  
 Retirer la lampe épuisée  
 Die alte Lampe entnehmen  
 Verwijder de lege lamp  
 Quitar la lámpara agotada  
 Tag den udtjente pære ud  
 Fjerne den utbrænte lyspæren  
 Ta bort den förbrukade lampan  
 Вынуть старую лампочку  
 取出老化的灯泡

**Portarla in un centro di riciclaggio**  
 Carry it to a recycling centre  
 La porter dans une déchetterie pour son recyclage  
 Ordnungsgemäß entsorgen  
 Breng de lamp naar een recyclingcentrum  
 Llevarla a un centro de reciclaje  
 Aflever den på en genbrugsstation  
 Lever den til en miljøstasjon  
 Lämna in den till en återvinningsanläggning  
 Сдать ее в пункт приема утильсырья  
 将其送往回收中心

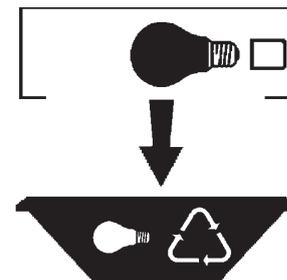

**Inserire la nuova lampada**  
 Introduce the new lamp  
 Installer la lampe neuve  
 Die neue Lampe einsetzen  
 Doe de nieuwe lamp op zijn plek  
 Montar la nueva lámpara  
 Sæt den nye pære i  
 Sette i den nye pæren  
 Sätt i den nya lampan  
 Вставить новую лампочку  
 装入新灯泡

**Inserire la nuova lampada nel portalampana**  
 Fit the new lamp into the socket  
 Installer la nouvelle lampe dans le support de lampe  
 Die neue Lampe in den Sockel einsetzen  
 Doe de nieuwe lamp in de lamphouder  
 Montar la nueva lámpara en el portalampana  
 Sæt den nye pære i fatningen  
 Sette den nye pæren inn i lampeholderen  
 Sätt i den nya lampan i lamphållaren  
 Вставить новую лампочку в патрон  
 将新灯泡插入灯泡架中

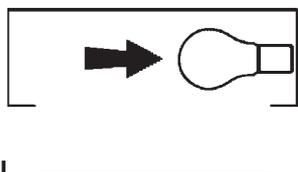

**Riposizionare ottica**  
 Re-place the optic  
 Remettre l'optique à sa place  
 Die Optik wieder einsetzen  
 Doe de optiek weer op zijn plaats  
 Volver a montar la óptica  
 Sæt den optiske enhed på plads  
 Innstille linsen  
 Flytta om optiken  
 Отрегулировать линзы  
 重新定位光头

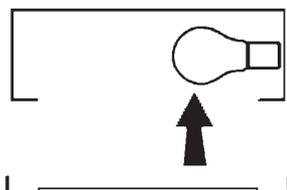

**Effettuare prova di funzionamento**  
 Perform operative test  
 Procéder à un essai de fonctionnement  
 Eine Funktionsprüfung durchführen  
 Controleer de correcte werking  
 Hacer una prueba de funcionamiento  
 Afprøv funktionen  
 Prøve om den fungerer  
 Utför funktionstest  
 Выполнить проверку исправности работы  
 执行功能测试

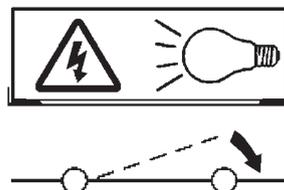

- I Istruzioni per la pulizia dell'apparecchio di illuminazione  
 GB Instructions on luminaire cleaning operations  
 F Instructions pour le nettoyage du luminaire  
 D Anweisungen zur Reinigung der Leuchte  
 NL Instructies voor de reiniging van de verlichtingsarmatuur  
 E Instrucciones para limpiar el aparato de alumbrado  
 DK Anvisninger i rengøring af belysningsarmaturet  
 N Anvisninger for rengjøring av lysapparatet  
 S Instruktioner för rengöring av belysningsanordningen  
 RUS Инструкции по чистке осветительного прибора  
 CN 照明装置清洁说明

Pulire l'apparecchio  
 Clean the fixture  
 Nettoyer le luminaire  
 Das Gerät reinigen  
 Reinig het apparaat  
 Limpiar el aparato  
 Rengør armaturet  
 Rengjøre apparatet  
 Rengör anordningen  
 Чистка прибора  
 清洁装置

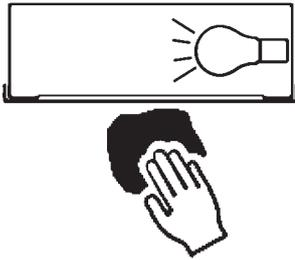

Spegnimento  
 Switch it off  
 Extinction  
 Ausschaltung  
 Uitschakeling  
 Apagado  
 Slukning  
 Slukking  
 Släckning  
 Выключение  
 关灯

Interrompere l'alimentazione dell'apparecchio  
 Cut the power supply to the luminaire  
 Couper l'alimentation du luminaire  
 Stromversorgung der Leuchte unterbrechen  
 Onderbreek de voeding van het apparaat  
 Interrumpir la alimentación del aparato  
 Afbryd armaturets strømforsyning  
 Avbryt strømtilførselen til apparatet  
 Koppla från anordningens strömförsörjning  
 Отключить электропитание прибора  
 中断装置供电

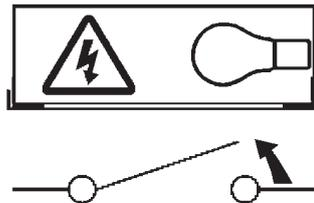

Spolverare l'ottica esterna  
 Remove dust from the external optic  
 Dépoussiérer l'optique extérieure  
 Die externe Optik abstauben  
 Stof de externe optiek af  
 Quitar el polvo de la óptica exterior  
 Tør støvet af den udvendige optiske enhed  
 Fjerne støv fra den eksterne lysenheden  
 Damma av den yttre optiken  
 Вытереть пыль с внешней стороны линз  
 为外侧镜头掸尘

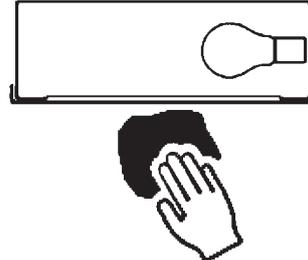

Lavare l'ottica esterna  
 Wash the external optic  
 Laver l'optique extérieure  
 Die externe Optik waschen  
 Was de externe optiek  
 Lavar la óptica exterior  
 Vask den udvendige optiske enhed  
 Vaske den eksterne lysenheden  
 Rengör den yttre optiken  
 Вымыть линзы с внешней стороны  
 清洁外镜头

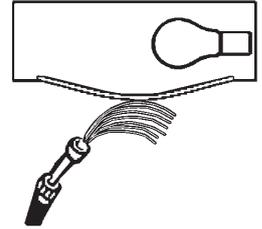

Rimuovere l'ottica  
 Remove the optic  
 Retirer l'optique  
 Die Optik abnehmen  
 Verwijder de optiek  
 Quitar la óptica  
 Tag den optiske enhed af  
 Fjerne lysenheden  
 Ta bort optiken  
 Снять линзы  
 取下镜头

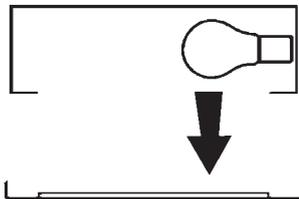

Pulire la parte interna dell'apparecchio di illuminazione  
 Clean the inside of the fixture  
 Nettoyer l'intérieur du luminaire  
 Die Innenseite der Leuchte reinigen  
 Reinig de binnenzijde van de verlichtingsarmatuur  
 Limpiar el interior del aparato de alumbrado  
 Rengør belysningsarmaturets indvendige dele  
 Rengjøre lysapparatet innvendig  
 Rengör belysningsanordningen invändigt  
 Протереть осветительный прибор изнутри  
 清洁照明装置内部



Riposizionare ottica  
 Re-place the optic  
 Remettre l'optique à sa place  
 Die Optik wieder einsetzen  
 Doe de optiek weer op zijn plaats  
 Volver a montar la óptica  
 Sæt den optiske enhed på plads  
 Innstille linsen  
 Flytta om optiken  
 Отрегулировать линзы  
 重新定位镜头

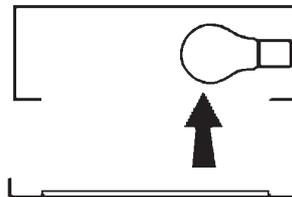

Effettuare prova di funzionamento  
 Perform operative test  
 Procéder à un essai de fonctionnement  
 Eine Funktionsprüfung durchführen  
 Controleer de correcte werking  
 Hacer una prueba de funcionamiento  
 Afprøv funktionen  
 Prøve om den fungerer  
 Utför funktionstest  
 Выполнить проверку исправности работы  
 执行功能测试

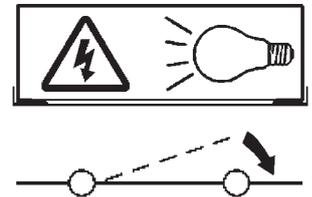

- I Istruzioni per il fine vita e lo smaltimento dei componenti**  
**GB Instructions on end-of-life and component disposal**  
**F Instructions pour la gestion des composants en fin de vie et leur mise au rebut**  
**D Anweisungen zur Entsorgung der Leuchtenkomponenten**  
**NL Instructies voor het verwijderen van de armatuur en het recyclen van de onderdelen**  
**E Instrucciones para el final de vida y la eliminación los componentes**  
**DK Anvisninger i udtjent armatur og bortskaffelse af komponenter**  
**N Anvisninger for endt levetid og avfallsbehandling av delene**  
**S Instruktionser vid bortskaffning och kassering av komponenter**  
**RUS Инструкции по утилизации прибора и его комплектующих по окончании его срока службы**  
**CN 寿命期结束与零件废弃处置说明**

Spegnimento  
Switch it off  
Extinction  
Ausschaltung  
Uitschakeling  
Apagado  
Slukning  
Slukking  
Släckning  
Выключение  
关灯

Interrompere l'alimentazione dell'apparecchio  
Cut the power supply to the luminaire  
Couper l'alimentation du luminaire  
Stromversorgung der Leuchte unterbrechen  
Onderbreek de voeding van het apparaat  
Interrompirla alimentación del aparato  
Afbryd armaturets strømforsyning  
Avbryt strømtilførselen til apparatet  
Koppla från anordningens strömförsörjning  
Отключить электропитание прибора  
中断装置供电



Rimuovere la/e lampada/e per la dismissione  
Remove the lamp(s) for decommissioning  
Retirer la(les) lampe(s) pour sa(leur) mise au rebut  
Die Lampe/n ordnungsgemäß entsorgen  
Verwijder de lamp(en) voor het recyclen  
Quitar la(s) lámpara(s) para el desecho  
Tag pæren/pærerne ud til bortskaffelse  
Fjerne lampen/-e som skal kastes  
Ta bort lampan/-orna för bortskaffningen  
Вынуть лампочку/и для утилизации прибора  
取出需要丢弃的灯泡

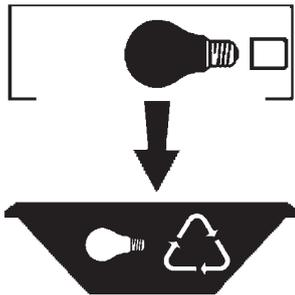

Rimuovere la batteria per la dismissione  
Remove the battery for decommissioning  
Retirer la batterie pour sa mise au rebut  
Die Batterie ordnungsgemäß entsorgen  
Verwijder de batterij voor het recyclen  
Quitar la batería para el desecho  
Tag batteriet ud til bortskaffelse  
Fjerne batteriet som skal kastes  
Ta bort batteriet för bortskaffningen  
Вынуть батарейку для утилизации прибора  
取出需要丢弃的电池

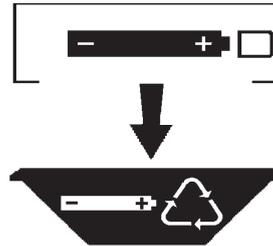

Rimuovere l'apparecchio per la dismissione  
Remove the fixture for decommissioning  
Enlever le luminaire pour sa mise au rebut  
Das Gerät ordnungsgemäß entsorgen  
Verwijder het apparaat voor het recyclen  
Quitar el aparato para el desecho  
Tag armaturet ud til bortskaffelse  
Fjerne apparatet som skal kastes  
Ta bort anordningen för bortskaffningen  
Снять прибор для утилизации  
取出需要丢弃的装置

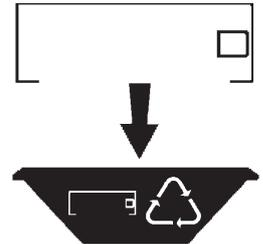

Inviare i materiali ad un centro di raccolta  
RAEE  
Send the materials to a WEEE collection  
centre  
Envoyer les matériaux dans une déchetterie  
DEEE  
Die Materialien in einem WEEE-Zentrum  
entsorgen  
Zend de materialen naar een recyclingscentrum  
voor de AEEA  
Enviar los materiales a un centro de recogida  
RAEE  
Afløver materialerne på et indsamlingscenter  
for elektronisk udstyr  
Sende materialene til en miljøstasjon for  
resirkulering av EE-avfall  
Skicka materialet till en RAEE uppsamlingscentral  
Сдать материалы в пункт приема утильсырья  
将材料送往电气和电子垃圾回收中心

