

Collection of recessed downlights for architectural applications. Excellent build quality with features for the most demanding professional applications. Available in 2 apertures with complete light distributions offering fixed, adjustable and wall washer optics. Generous light outputs with excellent chromatic performance and enhanced visual comfort (UGR<10). Also available with a Safety glass with a sealing system to increase the IP rating (IP65).

Luminaire characteristic: Power input system: 10.5W to 13W
Lumens for 3000K, 90CRI: 591lm to 1 026lm
Luminaire efficacy for 3000K, 90CRI: Up to 79lm/W

Source: COB LED module (LM-80)
2700K: 90CRI,
3000K: 90CRI,
3500K: 90CRI,
4000K: 90CRI.

Lumen maintenance: 90% of initial lumens at 50 000 hours (L90) (LM-79).

Optic: Fixed: Deep recessed reflector available with medium, flood, wide flood or very wide flood optic. Adjustable: Deep recessed reflector available with spot, medium, flood or wide flood optic. Optical assembly hot aiming adjustment: Comfort optic type: 30° tilt. Super comfort optic type: 30° tilt and 355°pan. Wall washer: Wall washer with lens. Visual comfort: UGR < 10

Material: Body: Die-cast aluminum optical assembly
Reflector: Metalized polycarbonate
Baffle: Painted thermoplastic
Housing: Galvanized steel

Mounting: New construction with housing suitable for airtight applications. (page 5).

Electrical: Integral high efficiency LED driver rated at 50 000 hours, 120V or 277V.

Dimming: 0-10V (120-277V), down to 5%. Leading edge (TRIAC) and trailing edge (ELV) (120V only), down to 5%. DALI (120-277V), down to 0.1%.

Finish: Powder coated body and painted metallized baffle. See page 2 for complete offering.

Weight: Trim: 0.57lb (0.26kg),
Trimless: 0.29lb (0.13kg).

Warranty: 5 year limited warranty.

Rating: IP20, IP44 (under the ceiling for trim fixed)
IP23 (under the ceiling for trim adjustable)
IP65 (under the ceiling, see page 2 for availability)

Certification: cULus listed for damp location. Interior use only.



Title 24-JA8-2019 high efficiency luminaire. Airtight luminaire less than 2 cfm leakage @1.57PSI per ASTM E283. To confirm which versions are certified, please consult the product list: <https://cacertappliances.energy.ca.gov/Pages/Search/AdvancedSearch.aspx>

ORDERING INFO



PRODUCT CODE				INSTALLATION CODE					
SHAPE	MOUNTING	INSTALLATION	LED	OPTIC TYPE	OPTIC	VOLTAGE	FINISH (trim finish / baffle finish)	DIMMING**	
R Round	T Trim	AT Airtight housing	927 2700K, 90CRI	SGF ¹ Comfort fixed	SP ⁴ Spot 16°	120 120V	TRIM	120V	
	L Trimless		930 3000K, 90CRI	SGA ¹ Comfort adjustable	MD Medium 26°		01 White / black		LTE Leading and Trailing edge dimming (down to 5%)
			935 3500K, 90CRI	SCF Super comfort fixed	FL ⁵ Flood 39°	UNV 120-277V	02 Black / black	UNV (120-277V)	
			940 4000K, 90CRI	SCA Super comfort adjustable	WF ⁶ Wide flood 44°		31 White / white	D10 0-10V (down to 5%)	
				FWW ² Fixed wall washer	VW ⁷ Very wide flood 56°		41 [*] White / gold	ED10 [*] 0-10V eldoLED ECOdrive (down to 1%)	
				WGF ^{1 3} Comfort fixed IP65			E4 [*] White / chrome	SD10 [*] 0-10V eldoLED SOLOdrive (down to 0.1%)	
							E7 [*] White / black chrome	EDA [*] DALI eldoLED ECOdrive (down to 1%)	
							E9 [*] White / gold matte	SDA [*] DALI eldoLED SOLOdrive (down to 0.1%)	
							TRIMLESS		
							31 White		
							02 Black		
							04 [*] Chrome		
							14 [*] Gold		
							E6 [*] Black chrome		
							E8 [*] Gold matte		

⁽¹⁾ Available with trim (T) mounting.

⁽²⁾ No optic selection necessary when ordering the fixed wall washer (FWW) optic type.

⁽³⁾ Available with 2700K, 90CRI (927) LED.

⁽⁴⁾ Available for adjustable (SGA, SCA) optic type.

⁽⁵⁾ Available for super comfort adjustable (SCA) optic type.

⁽⁶⁾ Available for comfort (SGF, SGA, WGF) optic type. Also available for super comfort fixed (SCF) optic type.

⁽⁷⁾ Available for fixed (SGF, SCF) optic type.

* May require a longer lead time than standard. Please contact customer service for details.

** Dimming levels will vary depending on the dimmer used and the number of luminaires on the line.

TRIM MODELS DIMENSIONS

FIXED OPTIC

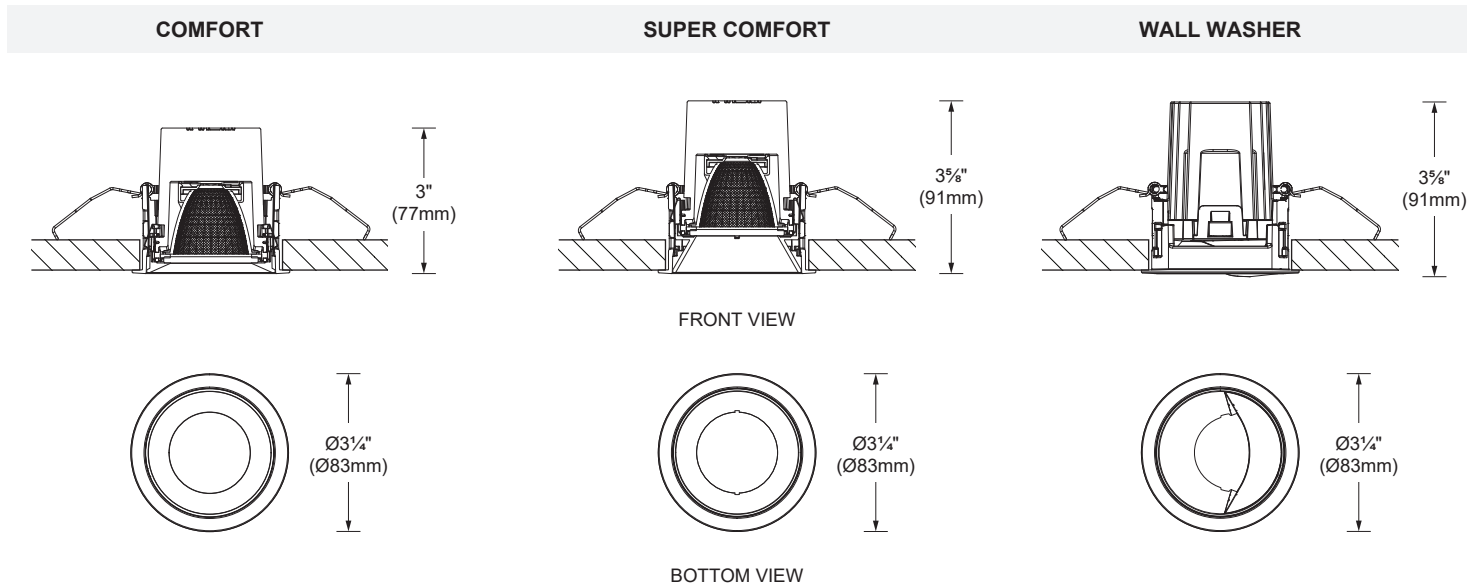

ADJUSTABLE OPTIC

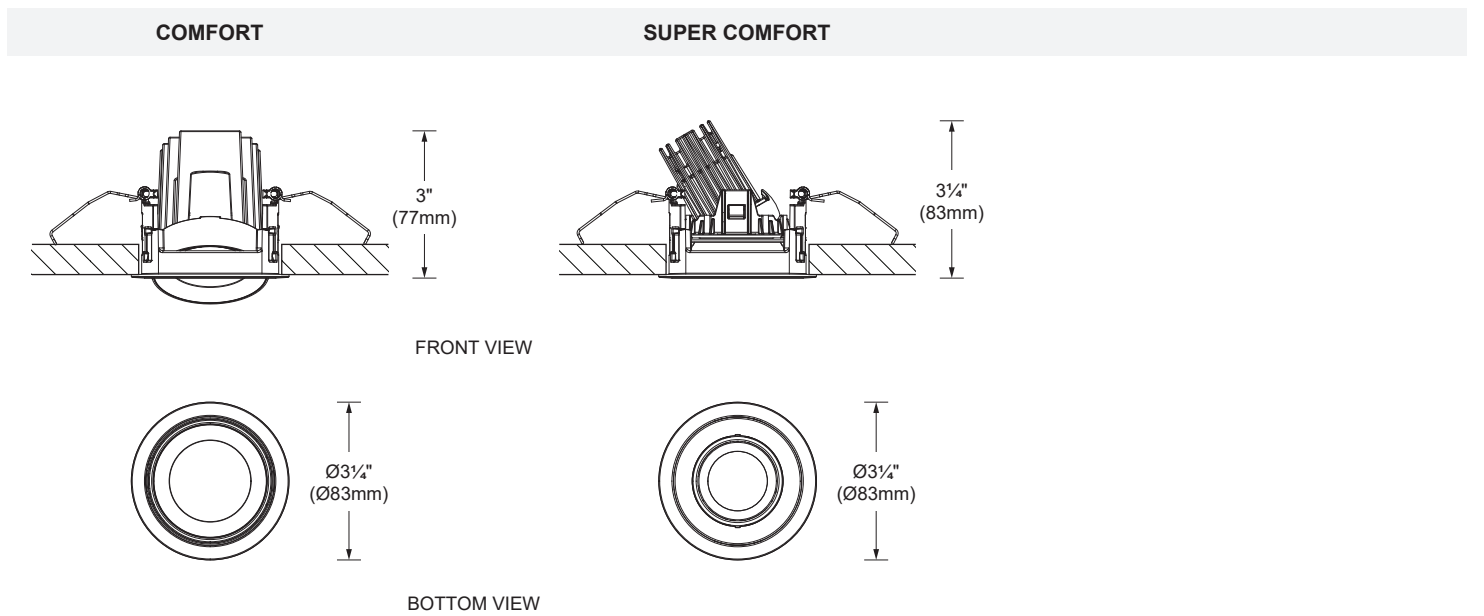

TRIMLESS MODELS DIMENSIONS

FIXED OPTIC

SUPER COMFORT

WALL WASHER

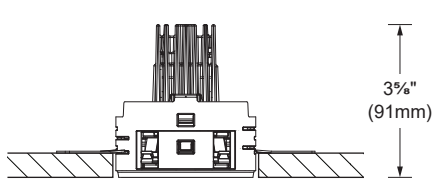

3 3/4"
(91mm)

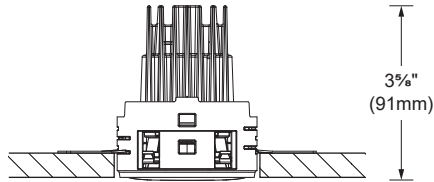

3 3/4"
(91mm)

FRONT VIEW



Ø3"
(Ø75mm)

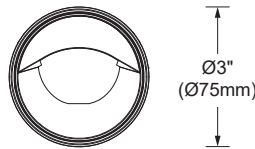

Ø3"
(Ø75mm)

BOTTOM VIEW

ADJUSTABLE OPTIC

SUPER COMFORT

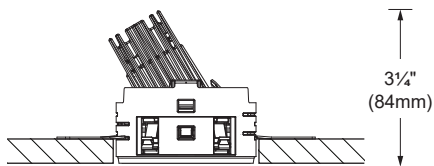

3 1/4"
(84mm)

FRONT VIEW



Ø3"
(Ø75mm)

BOTTOM VIEW

INSTALLATION

New construction with airtight (AT) housing.

Housing with hanger bars system for new construction installations.
Suitable for insulated ceiling, Chicago Plenum and airtight applications.
Housing can be shipped separately.

Ceiling thickness:

Trim: 1/8" to 7/8" (3mm - 22mm)
Trimless: 1/2" to 19/16" (12.5mm - 24mm)

Total weight:

Trim: 7.05lb (3.2kg),
Trimless: 6.9lb (3.13kg).

Hanger bars suitable for Grid ceiling

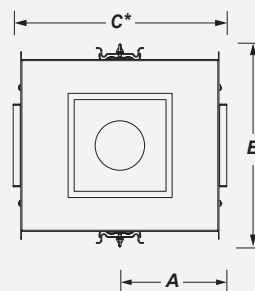
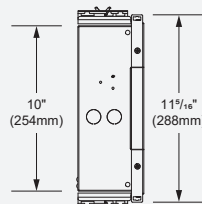
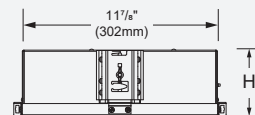
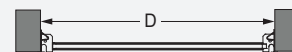
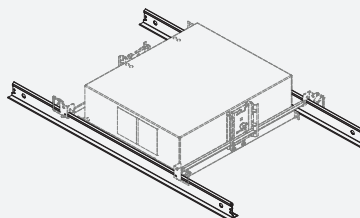







*Provide a minimum of 1 5/8" (46mm) on each side for the hanger bar fixations

Model	Housing	Cut-out dimensions	Cut-out position (A)	Max Overall dimensions (BxC*)	Hanger bars (D)	Clearance (H)
LASER 75	BI-LAS75-RT-AT	Ø 3" (Ø 75mm)	6 7/16" (164mm)	12 1/4" x 12 15/16" (311 x 328mm)	14 1/4" to 26" (362 to 660mm)	4" (102mm)
	BI-LAS75-RLF-AT					
	BI-LAS75-RLA-AT					

ACCESSORIES (TO BE ORDERED SEPARATELY)

Fixture can hold a maximum of 3 accessories at a time.

	PRODUCT CODE	COMFORT FIXED	COMFORT ADJUSTABLE	SUPER COMFORT FIXED
HONEYCOMB LOUVRE 	IMY22-04 - Black	<input type="checkbox"/>	<input type="checkbox"/>	<input type="checkbox"/>
DIFFUSER GLASS 	IMY23-65	<input type="checkbox"/>	<input type="checkbox"/>	<input type="checkbox"/>
REFRACTOR LENS (for elliptical distribution) 	IMY24-24	<input type="checkbox"/>	<input type="checkbox"/>	<input type="checkbox"/>
DECORATIVE RINGS 	IMY26-05 - Red	<input type="checkbox"/>	<input type="checkbox"/>	<input type="checkbox"/>
	IMY26-06 - Yellow	<input type="checkbox"/>	<input type="checkbox"/>	<input type="checkbox"/>
	IMY26-16 - Blue	<input type="checkbox"/>	<input type="checkbox"/>	<input type="checkbox"/>
INTERNAL ANTI-GLARE RING 	IMY27-04 - Black		<input type="checkbox"/>	
DECORATIVE CYLINDERS 	IMY28-05 - Red	<input type="checkbox"/>		
	IMY28-06 - Yellow	<input type="checkbox"/>		
	IMY28-16 - Blue	<input type="checkbox"/>		
	IMY28-24 - Clear transparent	<input type="checkbox"/>		

PHOTOMETRIC DATA

**COMFORT
FIXED**



CCT (K)	CRI	LOAD (W)	OPTIC	LUMENS (lm)	EFFICACY (lm / W)	MAX CANDELA (cd)	MODELS
3000K	90	13W	Medium 26°	986	76	4 183	ILAS75RXXX-930-SGFMD
			Wide flood 46°	1 011	78	1 981	ILAS75RXXX-930-SGFWF
			Very wide flood 56°	1 012	78	1 344	ILAS75RXXX-930-SGFVW

Use multiplier table for other CCT and CRI output data. Efficacy based on IESNA LM-79 test reports. Visit iguzzini.com/us for complete photometric data.

Medium 26° (3000K, 90CRI)

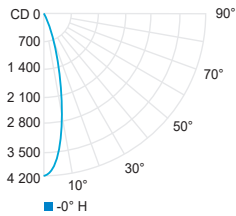

Center beam fc	Beam width ft
2ft	1 046 0.9
4ft	261 1.9
6ft	116 2.8
8ft	65.4 3.7
10ft	41.8 4.7
12ft	29 5.6

Wide flood 46° (3000K, 90CRI)

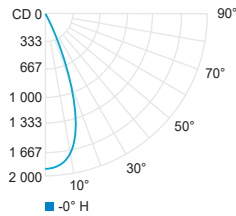

Center beam fc	Beam width ft
2ft	491 1.6
4ft	123 3.1
6ft	54.5 4.7
8ft	30.7 6.2
10ft	19.6 7.8
12ft	13.6 9.3

Very wide flood 56° (3000K, 90CRI)

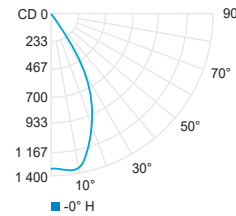

Center beam fc	Beam width ft
2ft	329 2.0
4ft	82.3 4.1
6ft	36.6 6.1
8ft	20.6 8.2
10ft	13.2 10.2
12ft	9.15 12.3

**COMFORT
ADJUSTABLE**



CCT (K)	CRI	LOAD (W)	OPTIC	LUMENS (lm)	EFFICACY (lm / W)	MAX CANDELA (cd)	MODELS
3000K	90	13W	Spot 16°	948	73	6 149	ILAS75RXXX-930-SGASP
			Medium 26°	973	75	4 232	ILAS75RXXX-930-SGAMD
			Wide flood 44°	986	76	1 973	ILAS75RXXX-930-SGAWF

Use multiplier table for other CCT and CRI output data. Efficacy based on IESNA LM-79 test reports. Visit iguzzini.com/us for complete photometric data.

Spot 16° (3000K, 90CRI)

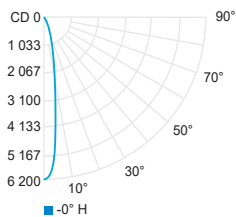

Center beam fc	Beam width ft
2ft	1 537 0.6
4ft	384 1.1
6ft	171 1.7
8ft	96.1 2.3
10ft	61.5 2.9
12ft	42.7 3.4

Medium 26° (3000K, 90CRI)

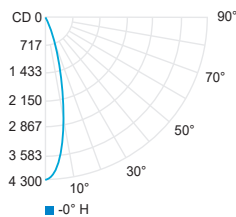

Center beam fc	Beam width ft
2ft	1 058 0.9
4ft	265 1.8
6ft	118 2.7
8ft	66.1 3.7
10ft	42.3 4.6
12ft	29.4 5.5

Wide flood 44° (3000K, 90CRI)

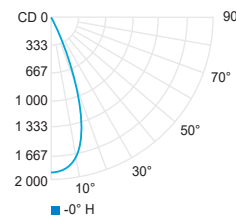

Center beam fc	Beam width ft
2ft	493 1.6
4ft	123 3.3
6ft	54.8 4.9
8ft	30.8 6.5
10ft	19.7 8.1
12ft	13.7 9.8

CCT options	2700K	3000K	3500K	4000K
CRI options	90CRI	90CRI	90CRI	90CRI
Multiplier	0.96	1	1.04	1.07

PHOTOMETRIC DATA

**SUPER COMFORT
FIXED**



CCT (K)	CRI	LOAD (W)	OPTIC	LUMENS (lm)	EFFICACY (lm / W)	MAX CANDELA (cd)	MODELS
3000K	90	13W	Medium 26°	986	76	4 295	ILAS75RXXX-930-SCFMD
			Wide flood 44°	1 026	79	2 084	ILAS75RXXX-930-SCFWF
			Very wide flood 56°	1 000	77	1 343	ILAS75RXXX-930-SCFVW

Use multiplier table for other CCT and CRI output data. Efficacy based on IESNA LM-79 test reports. Visit iguzzini.com/us for complete photometric data.

Medium 26° (3000K, 90CRI)

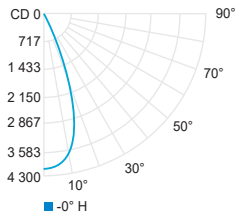

	Center beam fc	Beam width ft
2ft	1 074	0.9
4ft	268	1.8
6ft	119	2.8
8ft	67.1	3.7
10ft	43	4.6
12ft	29.8	5.5

Wide flood 44° (3000K, 90CRI)

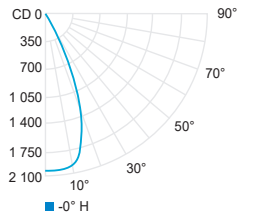

	Center beam fc	Beam width ft
2ft	521	1.6
4ft	130	3.3
6ft	57.9	4.9
8ft	32.6	6.5
10ft	20.8	8.1
12ft	14.5	9.8

Very wide flood 56° (3000K, 90CRI)

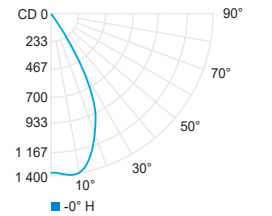

	Center beam fc	Beam width ft
2ft	328	2.1
4ft	82.1	4.1
6ft	36.5	6.2
8ft	20.5	8.2
10ft	13.1	10.3
12ft	9.12	12.3

**SUPER COMFORT
ADJUSTABLE**



CCT (K)	CRI	LOAD (W)	OPTIC	LUMENS (lm)	EFFICACY (lm / W)	MAX CANDELA (cd)	MODELS
3000K	90	10.5W	Spot 14°	591	56	5 646	ILAS75RXXX-930-SCASP
			Medium 24°	656	62	3 450	ILAS75RXXX-930-SCAMD
			Flood 38°	648	62	1 595	ILAS75RXXX-930-SCAFL

Use multiplier table for other CCT and CRI output data. Efficacy based on IESNA LM-79 test reports. Visit iguzzini.com/us for complete photometric data.

Spot 14° (3000K, 90CRI)

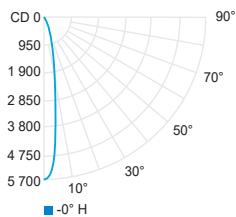

	Center beam fc	Beam width ft
2ft	1 412	0.4
4ft	353	0.9
6ft	157	1.3
8ft	88.2	1.8
10ft	56.5	2.2
12ft	39.2	2.7

Medium 24° (3000K, 90CRI)

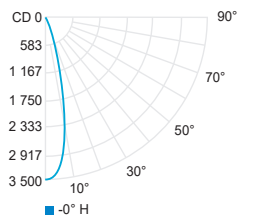

	Center beam fc	Beam width ft
2ft	863	0.8
4ft	216	1.6
6ft	95.8	2.5
8ft	53.9	3.3
10ft	34.5	4.1
12ft	24	4.9

Flood 38° (3000K, 90CRI)

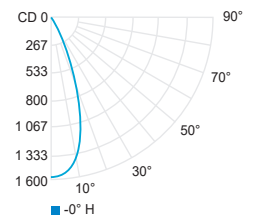

	Center beam fc	Beam width ft
2ft	399	1.4
4ft	99.7	2.8
6ft	44.3	4.2
8ft	24.9	5.6
10ft	16	7.0
12ft	11	8.5

CCT options	2700K	3000K	3500K	4000K
CRI options	90CRI	90CRI	90CRI	90CRI
Multiplier	0.96	1	1.04	1.07

PHOTOMETRIC DATA

WALL WASHER

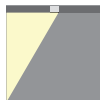

CCT (K)	CRI	LOAD (W)	OPTIC	LUMENS (lm)	EFFICACY (lm / W)	MAX CANDELA (cd)	MODELS
3000K	90	13W	Wall washer	700	54	506	ILAS75RXXX-930-FWW

Use multiplier table for other CCT and CRI output data. Efficacy based on IESNA LM-79 test reports. Visit iguzzini.com/us for complete photometric data.

Wall washer (3000K, 90CRI)

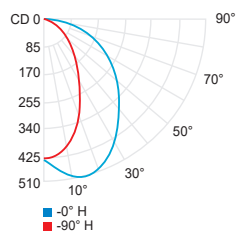

CCT options	2700K	3000K	3500K	4000K
CRI options	90CRI	90CRI	90CRI	90CRI
Multiplier	0.96	1	1.04	1.07

LED COLOR FIDELITY DATA

COMFORT • FIXED / ADJUSTABLE
SUPER COMFORT • FIXED
WALL WASHER

CRI	CCT	R1	R2	R3	R4	R5	R6	R7	R8	R9	R10	R11	R12	R13	R14	R15	Rf	Rg	Melanopic ratio
90	2700K	93	96	97	93	92	95	93	83	62	89	93	83	93	98	89	92	100	0.478
	3000K	93	95	96	94	93	94	94	86	67	88	94	80	94	97	91	92	100	0.547
	3500K	93	95	95	93	92	93	95	87	67	86	93	75	93	97	91	91	100	0.625
	4000K	92	94	95	92	91	92	95	86	64	85	91	70	92	97	90	90	98	0.718

SUPER COMFORT • ADJUSTABLE

CRI	CCT	R1	R2	R3	R4	R5	R6	R7	R8	R9	R10	R11	R12	R13	R14	R15	Rf	Rg	Melanopic ratio
90	2700K	94	98	99	95	95	98	90	79	54	94	98	90	95	100	88	93	99	0.492
	3000K	95	97	98	96	95	96	93	84	62	92	97	86	95	98	90	93	101	0.555
	3500K	93	96	98	94	93	95	93	82	57	90	95	79	94	98	89	92	98	0.640
	4000K	92	95	96	92	91	93	93	83	57	87	93	73	93	98	89	91	98	0.725