

SISTEMA U.F.O.

L	S
Large 600x600 mm	Small 400x400 mm

ATTENZIONE:

LA SICUREZZA DELL'APPARECCHIO E' GARANTITA SOLO CON L'USO APPROPRIATO DELLE SEGUENTI ISTRUZIONI; PERTANTO E' NECESSARIO CONSERVARLE.

WARNING:

THE SAFETY OF THIS FIXTURE IS GUARANTEED ONLY IF YOU COMPLY WITH THESE INSTRUCTIONS; REMEMBER TO CONSERVE IN A SAFE PLACE.

ATTENTION:

LA SECURITE DE L'APPAREIL N'EST GARANTIE QU'EN CAS D'UTILISATION CORRECTE DES INSTRUCTIONS SUIVANTES; IL FAUT PAR CONSEQUENT LES CONSERVER.

ACHTUNG:

DIE SICHERHEIT DES GERÄTES WIRD NUR DURCH SACHGEMÄSSE BEFOLGUNG NACHSTEHENDER ANWEISUNGEN GEWÄHRLEISTET; IHRE AUFBEWAHRUNG IST DESHALB SEHR WICHTIG.

ATTENTIE:

DE VEILIGHEID VAN DE APPARATUUR IS SLECHTS DAN GEGARANDEERD ALS MEN DE VOLGENDE INSTRUKTIES STRIKT OPVOLGT; DAAROM MOET MEN ZE OOK BEWAAREN.

ATENCION:

LA SEGURIDAD DEL APARATO SE GARANTIZA SOLO CUMPLIENDO CUIDADOSAMENTE LAS SIGUIENTES INSTRUCCIONES; POR ELLO, ES NECESARIO CONSERVARLAS.

BEMÆRK:

SIKKERHEDEN VED BRUG AF ARMATURET KAN KUN GARANTERES, HVIS DISSE ANVISNINGER FØLGES; SØRG DERFOR FOR AT GEMME DEM.

ADVARSEL:

SIKKERHETEN TIL DETTE APPARATET GARANTERES KUN HVIS DU OVERHOLDER DISSE INSTRUKSJONENE; HUSK Å OPPBEVARE DEM PÅ ET TRYGT STED.

OBSERVERA!

UTRUSTNINGENS SÄKERHET KAN ENDAST GARANTERAS OM DESSA ANVISNINGAR RESPEKTERAS I DETALJ. SPARA DÄRFÖR DESSA ANVISNINGAR FÖR FRAMTIDA KONSULTATION.

ВНИМАНИЕ:

МЫ ГАРАНТИРУЕМ БЕЗОПАСНУЮ ЭКСПЛУАТАЦИЮ ИЗДЕЛИЯ ТОЛЬКО ПРИ СОБЛЮДЕНИИ СЛЕДУЮЩИХ ИНСТРУКЦИЙ; С ЭТОЙ ЦЕЛЬЮ НЕОБХОДИМО СОХРАНИТЬ ДАННУЮ БРОШЮРУ.

警告:

为确保该装置安全，请遵守操作指示；并于安全场所放置。

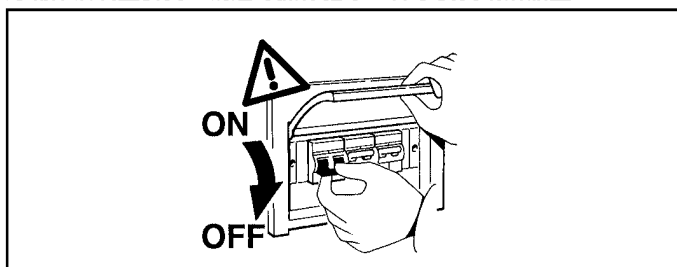

N.B.: DURANTE L'INSTALLAZIONE DEL SISTEMA RISPETTARE SCRUPolosAMENTE LE NORME IMPIANTISTICHE NAZIONALI VIGENTI.

N.B.: WHEN INSTALLING THE SYSTEM, MAKE SURE ALL CURRENT NATIONAL REGULATIONS RELATING TO INSTALLATION ARE OBSERVED.

N.B.: LORS DE L'INSTALLATION DU SYSTÈME VEUILLEZ RESPECTER RIGOREUSEMENT LES NORMES EN VIGUEUR EN LA MATIÈRE DANS LE PAYS.

N.B.: BEAHTENSIE BEI DER INSTALLATION DES SYSTEMS UNBEDINGT DIE IM LAND GELTENDEN ANLAGETECHNISCHEN VORSCHRIFTEN.

N.B.: BIJ HET INSTALLEREN VAN HET SYSTEEM MOET U DE GELDENDEN NATIONALE INSTALLATIENORMEN STRIKT NALEVEN.

NOTA: DURANTE LA INSTALACION DEL SISTEMA RESPETAR SCRUPolosAMENTE LAS NORMAS NACIONALES DE INSTALACION EN VIGOR.

N.B.: UNDER INSTALLATION AF SYSTEMET SKAL MAN NØJE OVERHOLDE DE GÆLDENDE REGLER FOR DISSE ANLÆG.

N.B.: UNDER INSTALLASJON AV SYSTEMET MÅ DE NASJONALE ANLEGGSFORSKRIFTENE OVERHOLDES NØYE.

ÖBS! UNDER INSTALLATIONEN AV SYSTEMET SKA GÄLLANDE NATIONELLA INSTALLATIONS FÖRESKRIFTER RESPEKTERAS I DETALJ.

ПРИМЕЧАНИЕ: В ПРОЦЕССЕ МОНТАЖА СИСТЕМЫ СТРОГО СОБЛЮДАЙТЕ НАЦИОНАЛЬНЫЕ ДЕЙСТВУЮЩИЕ НОРМАТИВЫ ПО ЭЛЕКТРОПРОВОДКЕ.

注意：在安装系统时请遵守设备的安装规定。

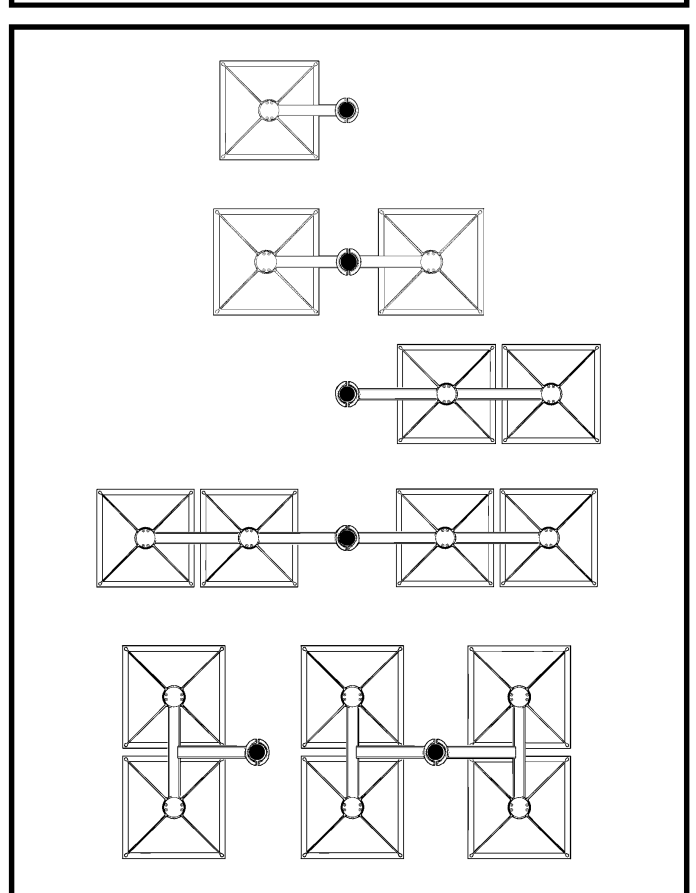
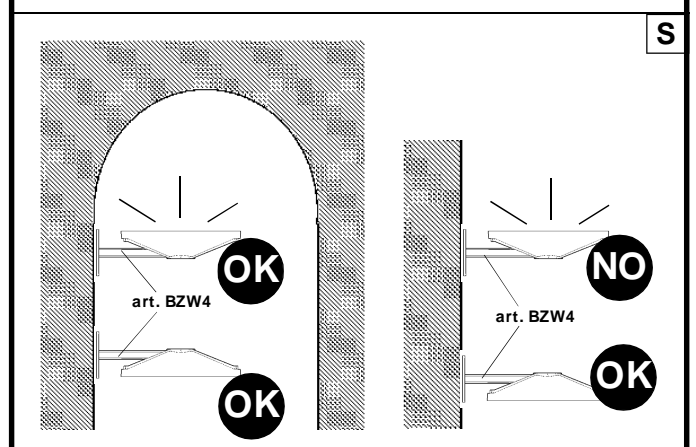
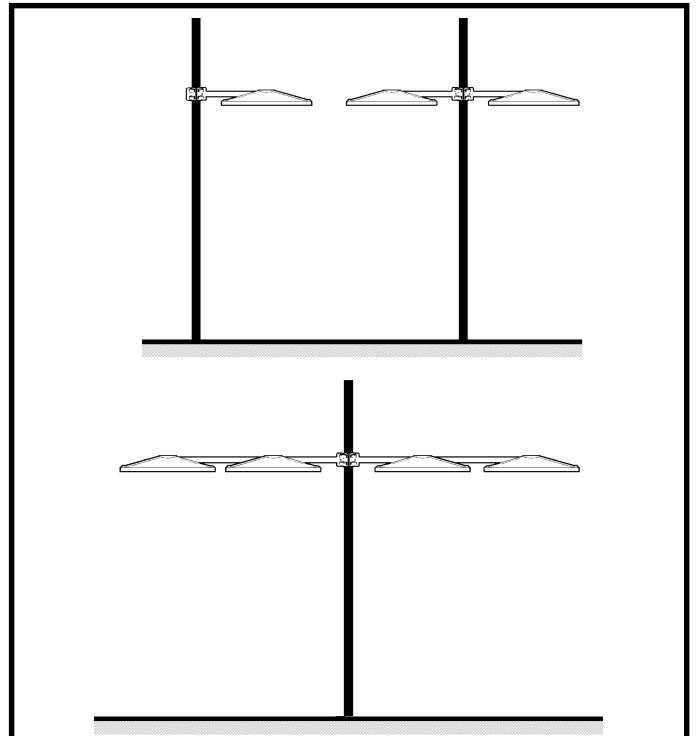

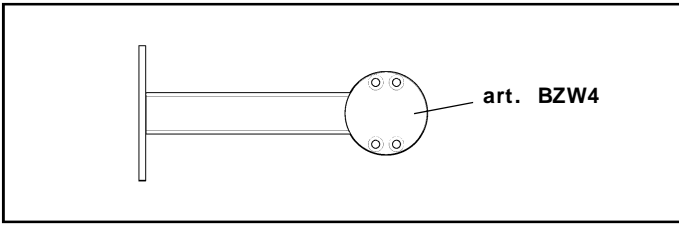

PALO - POLE - MAT - MAST - PAAL - POSTE - MAST STANG - STANG ФОНАРНЫЙ СТОЛБ 灯杆						
		Ø 76		Ø 102		Ø 120
	L	S	L	S	L	S
	art. BZP4	art. BZP3	art. BZP6	art. BZP5	art. BZP7	/
	/		L	S	L	S
	/		art. BZP8	art. BZU5	art. BZP9	/
	/		L	S	L	S
	/		art. BZQ0	art. BZU6	art. BZQ1	/
	L	S	L	S	L	S
	art. BZQ2		art. 6161		art. 6162	/
	/		art. BZM6		art. BZM7	

Ø L
60 mm ÷ 120 mm

Ø S
60 mm ÷ 102 mm

100 mm min

Ø 35 mm

Ø 102

Ø 120

Ø 22mm

Ø 76

45 mm

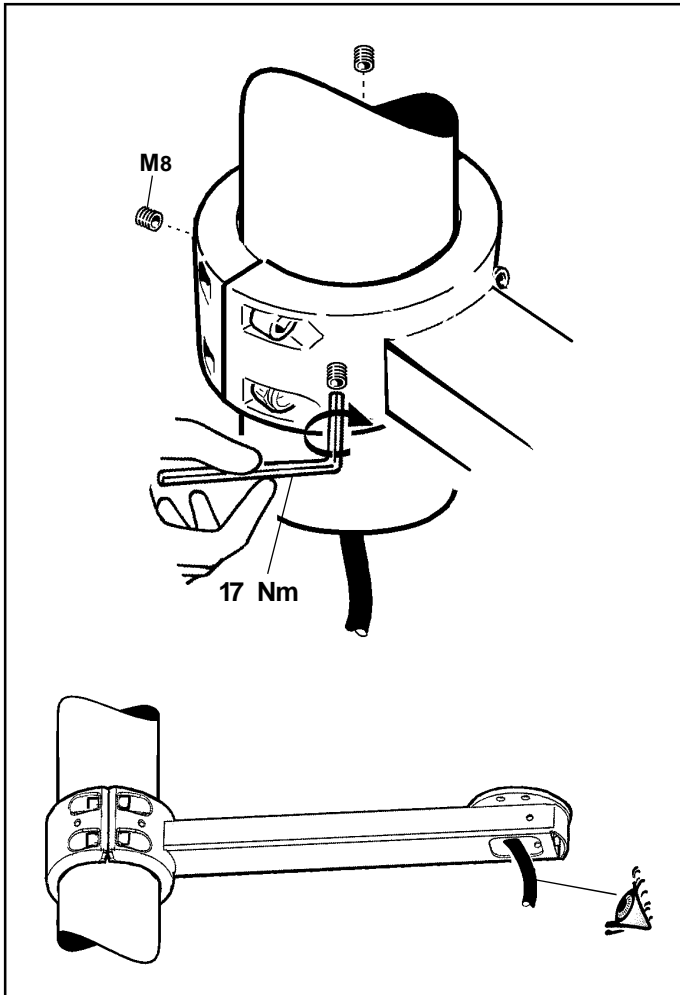
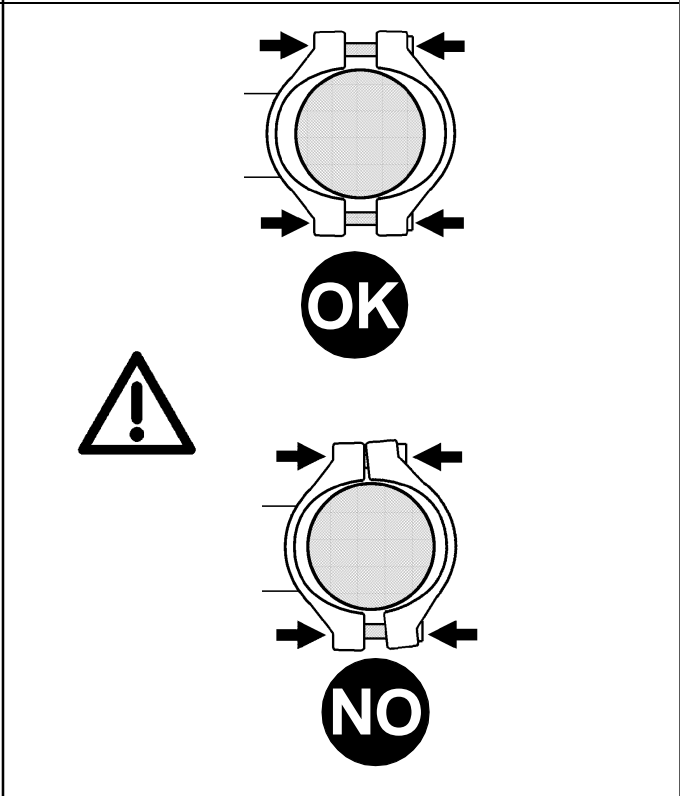
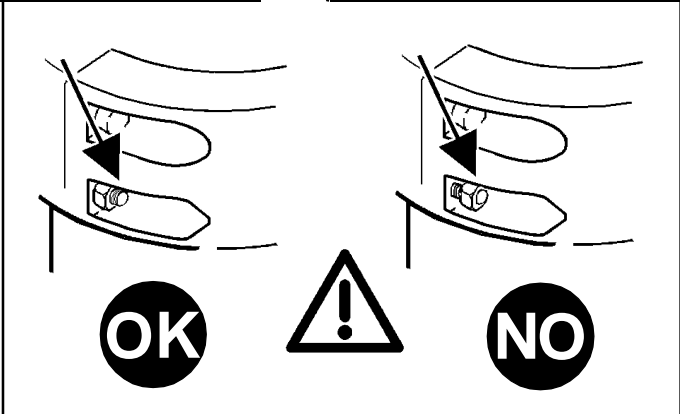
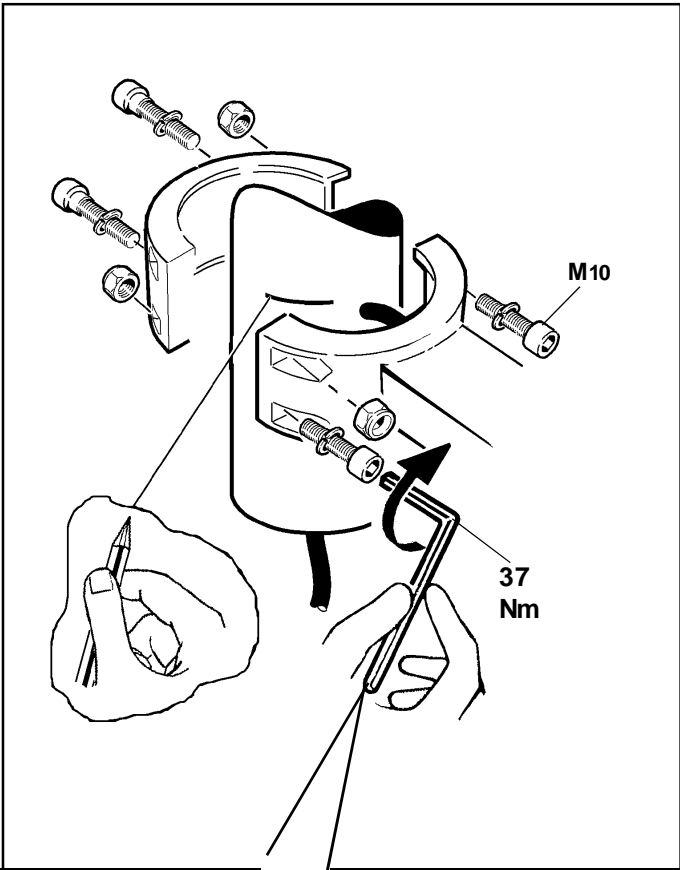

ART. BZW4

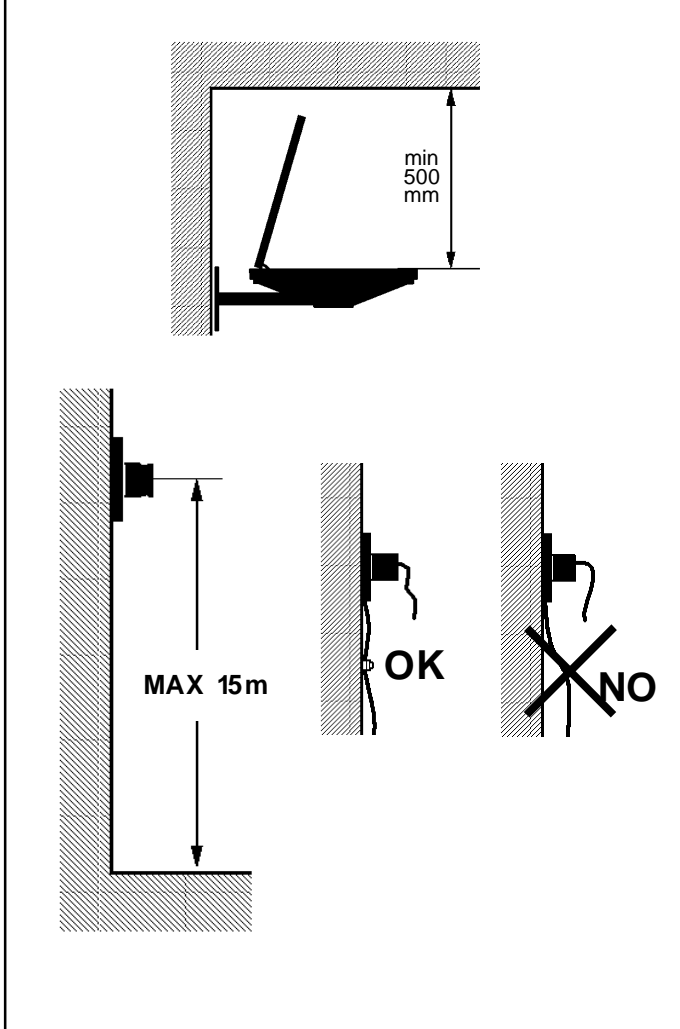

I Evitare che il peso del cavo o sue trazioni accidentali gravino sul prodotto.
N.B.: *Non sottoporre a trazioni superiori agli 80 N.

GB The cable weighing on the product or being accidentally tugged may cause damage to the product. Avoid both.
N.B.: *Do not subject to tugs greater than 80 N.

F Evitez que le poids du câble ou ses tractions accidentelles grèvent sur le produit.
N.B.: *Ne pas soumettre à des tractions dépassant 80 N.

D Achten Sie darauf, dass das Gewicht des Kabels oder eventuell auf dieses einwirkende, plötzliche Zugkräfte die Leuchte nicht belasten.
N.B.: *Vermeiden Sie eine Zugkraft von über 80 N.

NL Vermijd dat het gewicht van de kabels of accidentele tracties het product belasten.
N.B.: *Onderwerp ze niet aan een tractie die hoger is dan 80 N.

E Evitar cargar el peso del cable o sus tracciones accidentales sobre el producto.
NOTA: *No someter a tracciones superiores a 80 N.

DK Undgå, at produktet belastes af vægten fra ledningen eller utilsigtede trækpåvirkninger.
N.B.: *Forbindelsen må ikke udsættes for trækpåvirkninger på over 80 N.

N Kabelvekt på produktet eller ved å bli utilsikket strukket kan forårsake skade på produktet. Unngå begge.
N.B.: *Ikke utsett for drakrefter som er større enn 80 N.

S Undvik att kabelns vikt eller dess dragspänning sliter på utrustningen.
OBS! *Utsätt dem inte för dragkrafter över 80 N.

RUS Избегайте, чтобы вес кабеля или его случайного натяжение оказывали нагрузку на прибор.
ПРИМЕЧАНИЕ: *Не подвергать натяжению с усилием более 80 Н.

CN 电缆压在产品上或偶然拖拉可能会导致产品损坏。皆应避免。
注意: *请勿使其受大于的80N的拖曳力。

PER IL FISSAGGIO USARE TASSELLI AD ESPANSIONE CON VITI M 8; IL TIPO DI TASSELLO DA USARE (NYLON, ACCIAIO, A REAZIONE CHIMICA ...) E DA SCEGLIERE IN FUNZIONE DELLE CARATTERISTICHE DEL MATERIALE DI SUPPORTO (MURATURA, CALCESTRUZZO, METALLO ...) SU CUI VIENE APPLICATO IL PRODOTTO.
 FOR ATTACHMENT, USE EXPANSION PLUGS WITH M8 SCREW; CHOOSE THE TYPE OF PLUG (NYLON, STEEL, CHEMICAL REACTION ...) ACCORDING TO THE CHARACTERISTICS OF THE SURFACE (MASONRY, CONCRETE, METAL ...) TO WHICH IT IS APPLIED.

POUR LA FIXATION, UTILISEZ DES CHEVILLES A EXPANSION ET DES VIS M8, LE TYPE DE CHEVILLE DEVANT ÊTRE UTILISÉ (NYLON, ACIER, A REACTION CHIMIQUE ...) DOIT ÊTRE CHOISI EN FONCTION DES CARACTERISTIQUES DU MATERIAU DE SUPPORT (MAÇONNERIE, BETON, METAL ...) DU PRODUIT.

FÜR DIE BEFESTIGUNG SPREIZDÜBEL MIT SCHRAUBE M8 VERWENDEN; DER ZU VERWENDENDEN DÜBELTYP (AUS NYLON, STAHL, MIT CHEMISCHER REAKTION ...) HÄNGT VON DEN EIGENSCHAFTEN DES BEFESTIGUNGSMATERIALS (MAUERWERK, BETON, METALL ...) AN DEM DAS PRODUKT MONTIERT WIRD, AB.

VOOR HET BEVESTIGEN GEBRUIKT MEN EXPANSIEPLUGGEN MET SCHROEVEN M 8; HET TE GEBRUIKTE TYPE PLUG (NYLON, STAAL, CHEMISCH REAGEREND ...) HANGT AF VAN DE KENMERKEN VAN HET MATERIAAL WAAROP HET PRODUKT WORDT AANGEBRACHT (METSELWERK, BETON, METAL ...).

PARA LA FIJACION UTILIZAR TARUGOS DE EXPANSION CON TORNILLOS M8; EL TIPO DE TARUGO QUE DEBE USARSE (NYLON, ACERO, DE REACCION QUIMICA ...) DEBERA ELEGIRSE EN FUNCION DE LAS CARACTERISTICAS DEL MATERIAL DE SOPORTE (MAMPOSTERIA, HORMIGON, METAL ...) EN EL CUAL DEBE APLICARSE EL PRODUCTO.

FOR FASTGØRELSE SKAL MAN ANVENDE RAWLPLUGS MED SKRUE Ø 10. DE PLUGS, DER KAN ANVENDES (NYLON, STÅL, MED KEMISK REAKTION ...) SKAL VÆLGES UD FRA MONTERINGSFLADERNES EGENSKABER (MURVÆRK, BETON, METAL ...) HVOR PRODUKTET SKAL MONTERES.

FOR FESTE, BRUKEKSPANSJONSPLEGGER MED Ø 10 SKRUE. VELG TYPE PLEGG (NYLON, STÅL, KJEMISK REAKSJON ...) ETTER EGENSKAPENE PÅ OVERFLATEN (MUR, BETONG, METALL ...) SOM DE ER PÅFØRT.

FÖR FASTSÄTTNINGEN SKA EXPANSJONSPLEGGAR MED Ø 10 SKRUV ANVÄNDAS. TYPEN AV PLEGG (NYLON, STÅL, KEMISK REAKTION O.S.V.) SKA VÄLJAS BERÖENDE PÅ DET BÄRANDE MATERIALET'S EGENSKAPER (MURVERK, BETONG, METALL O.S.V.) DÄR PRODUKTEN APPLICERAS.

Для крепления используйте расширительные вкладыши с шурупами M8; тип используемого вкладыша (нейлон, сталь, с химической реакцией...) выбирается по характеристикам материала основания, к которому крепится система (кладка, бетон, металл...). К которому крепится прибор.

至于附加装置，使用带M8螺丝的膨胀塞；根据使用塞子的表面（砖石、混凝土、金属……）的特征选择塞子的类型（尼龙、钢、化学处理……）。

INTERASSI DI FORATURA
 CENTRE TO CENTRE DISTANCE BETWEEN HOLES
 ENTRE-AXES DE PERÇAGE
 ABSTAND DER BOHRLÖCHER
 AFSTANDEN TUSSEN DE GÅTEN
 DISTANCIA ENTRE LOS EJES DE PERFORACIÓN
 HULAFSTAND
 AVSTANDER FRA SENTER TIL SENTER MELLOM HULL
 AVSTÅND MELLANHÅL
 ШАГ ОТВЕРСТИЙ
 孔间的中心距离

ALIMENTAZIONE
 POWER SUPPLY
 ALIMENTATION
 EINSPEISUNG
 STROOMVERZORGING
 ALIMENTACION
 STRØMFORSYNING
 STRØMFORSYNING
 ELFÖRSÖRJNING
 ЭЛЕКТРОПИТАНИЕ
 电源

130 mm

2

1

430 mm

M8
 Serrare a fondo
 Tighten firmly
 Serrer à fond
 Fest einrasten
 Goed aanschroeven
 Enroscar en firme
 Skrues i bund
 Trekk til godt
 Dra åt botten
 Закрутить до упора
 紧固

ART. 6163 - 6164 - BZQ3

ART.	PALO - POLE - MAT MAST - PAAL - POSTE ФОНАРНЫЙ СТОЛБ 灯杆
	Ø mm
6163	89
6164	114
BZQ3	60

M5

5 Nm

M5

5 Nm

ART. BZM6 - BZM7

Serrare a fondo
Tighten firmly
Serrer à fond
Fest einrasten
Goed
aanschroeven
Enroscar en firme
Skrues i bund
Закрутить до упора
紧固

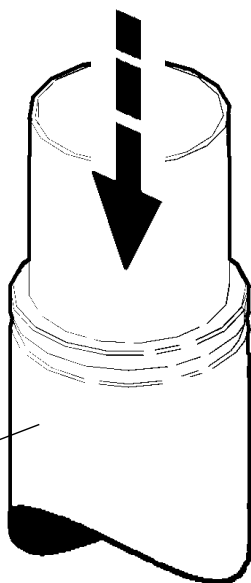
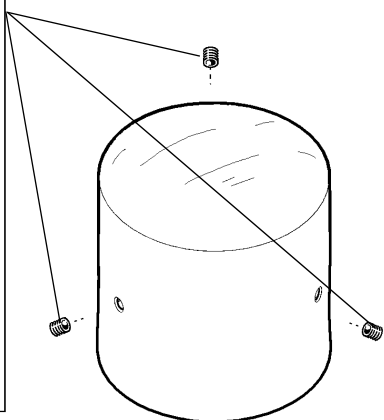
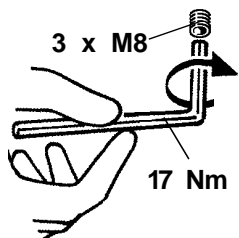

PALO
POLE
MAT
MAST
PAAL
POSTE
MAST
STANG
STÁNG
ФОНАРНЫЙ СТОЛБ
灯杆



Art.
BZM6
BZM7

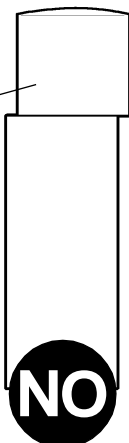

- I Per il cablaggio elettrico fare riferimento al foglio istruzioni del vano ottico.
GB Please refer to the optical assembly instruction sheet for the electric wiring.
F Pour le câblage électrique, se reporter à la notice d'instructions du groupe optique.
D Informationen zur elektrischen Verkabelung können Sie den Hinweisen zum Leuchtengehäuse entnehmen.
NL Voor de elektrische bedrading raadpleegt u het instructieblaadje in het armatuur.
E Para el cableado eléctrico hágase referencia a la hoja de instrucciones del vano óptico.
DK Se vejledningen til den optiske enhed for ledningsføring.
N Vennligst se instruksjonsarket for den optiske monteringen for den elektriske kablingen.
S Angående kabeldragingen, se instruktionsbladet för det optiska rummet.
RUS Порядок монтажа электропроводки смотрите в инструкциях к ламповому отсеку.
CN 针对布线，请参阅光学组件说明表。

Sistemi di installazione

ATTENZIONE:

LA SICUREZZA DELL'APPARECCHIO E' GARANTITA SOLO CON L'USO APPROPRIATO DELLE SEGUENTI ISTRUZIONI; PERTANTO E' NECESSARIO CONSERVARLE.

WARNING:

THE SAFETY OF THIS FIXTURE IS GUARANTEED ONLY IF YOU COMPLY WITH THESE INSTRUCTIONS; REMEMBER TO CONSERVE IN A SAFE PLACE.

ATTENTION:

LA SECUTIE DE L'APPAREIL N'EST GARANTIE QU'EN CAS D'UTILISATION CORRECTE DES INSTRUCTIONS SUIVANTES; IL FAUT PAR CONSEQUENT LES CONSERVER.

ACHTUNG:

DIE SICHERHEIT DES GERÄTES WIRD NUR DURCH SACHGEMÄSSE BEFOLGUNG NACHSTEHENDER ANWEISUNGEN GEWÄHRLEISTET; IHRE AUFBEWAHRUNG IST DESHALB SEHR WICHTIG.

ATTENTIE:

DE VEILIGHEID VAN DE APPARATUUR IS SLECHTS DAN GEGARANDEERD ALS MEN DE VOLGENDE INSTRUKTIES STRIKT OPVOLGT; DAAROM MOET MEN ZE OOK BEWAREN.

ATENCION:

LA SEGURIDAD DEL APARATO SE GARANTIZA SOLO CUMPLIENDO CUIDADOSAMENTE LAS SIGUIENTES INSTRUCCIONES; POR ELLO, ES NECESARIO CONSERVARLAS.

BEMÆRK:

SIKKERHEDEN VED BRUG AF ARMATURET KAN KUN GARANTERES, HVIS DISSE ANVISNINGER FØLGES; SØRG DERFOR FOR AT GEMME DEM.

ADVARSEL:

SIKKERHETENTIL DETTE APPARATET GARANTERES KUN HVIS DU OVERHOLDER DISSE INSTRUKSJONENE; HUSK Å OPPBEVARE DEM PÅ ET TRYGT STED.

OBSERVERA!

UTRUSTNINGENS SÄKERHET KAN ENDAST GARANTERAS OM DESSA ANVISNINGAR RESPEKTERAS I DETALJ. SPARA DÄRFÖR DESSA ANVISNINGAR FÖR FRAMTIDA KONSULTATION.

ВНИМАНИЕ:

МЫ ГАРАНТИРУЕМ БЕЗОПАСНУЮ ЭКСПЛУАТАЦИЮ ИЗДЕЛИЯ ТОЛЬКО ПРИ СОБЛЮДЕНИИ СЛЕДУЮЩИХ ИНСТРУКЦИЙ; С ЭТОЙ ЦЕЛЬЮ НЕОБХОДИМО СОХРАНИТЬ ДАННУЮ БРОШЮРУ.

警告:

为确保该装置安全，请遵守操作指示；并于安全场所放置。

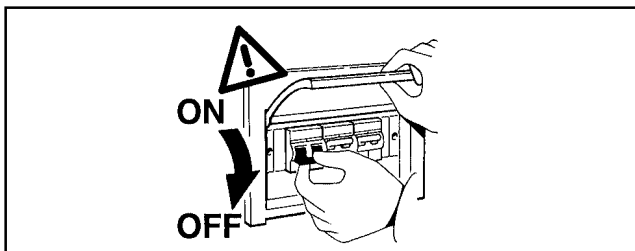

N.B.: DURANTE L'INSTALLAZIONE DEL SISTEMA RISPETTARE SCRUPOLOSAMENTE LE NORME IMPIANTISTICHE NAZIONALI VIGENTI.

N.B.: WHEN INSTALLING THE SYSTEM, MAKE SURE ALL CURRENT NATIONAL REGULATIONS RELATING TO INSTALLATION ARE OBSERVED.

N.B.: LORS DE L'INSTALLATION DU SYSTÈME VEUILLEZ RESPECTER RIGOREUSEMENT LES NORMES EN VIGUEUR EN LA MATIÈRE DANS LE PAYS.

N.B.: BEACHTEN SIE BEI DER INSTALLATION DES SYSTEMS UNBEDINGT DIE IM LAND GELTENDEN ANLAGETECHNISCHEN VORSCHRIFTEN.

N.B.: BIJ HET INSTALLEREN VAN HET SYSTEEM MOET U DE GELDENDE NATIONALE INSTALLATIENORMEN STRIKT NALEVEN.

NOTA: DURANTE LA INSTALACIÓN DEL SISTEMA RESPETAR ESCRUPULOSAMENTE LAS NORMAS NACIONALES DE INSTALACION EN VIGOR.

N.B.: UNDER INSTALLATION AF SYSTEMET SKAL MAN NØJE OVERHOLDE DE GÆLDENDE REGLER FOR DISSE ANLÆG.

N.B.: UNDER INSTALLASJON AV SYSTEMET MÁ DE NASJONALE ANLEGGSFORSKRIFTENE OVERHOLDES NØYE.

OBS! UNDER INSTALLATIONEN AV SYSTEMET SKA GÄLLANDE NATIONELLA INSTALLATIONSFORESKRIFTER RESPEKTERAS I DETALJ.

ПРИМЕЧАНИЕ: В ПРОЦЕССЕ МОНТАЖА СИСТЕМЫ СТРОГО СОБЛЮДАЙТЕ НАЦИОНАЛЬНЫЕ ДЕЙСТВУЮЩИЕ НОРМАТИВЫ ПО ЭЛЕКТРОПРОВОДКЕ.

注意：在安装系统时请遵守设备的安装规定。

WOW

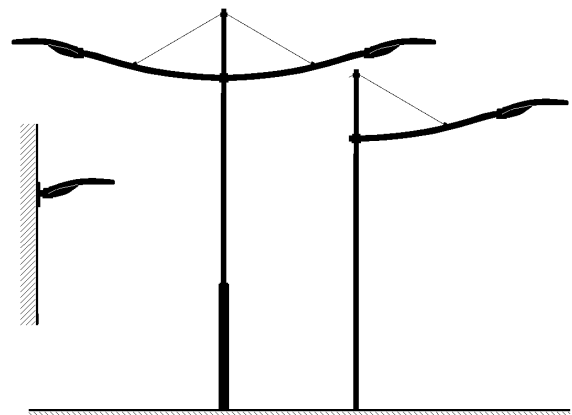
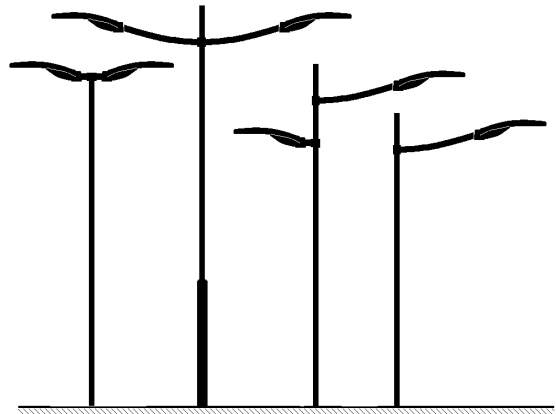

STREET

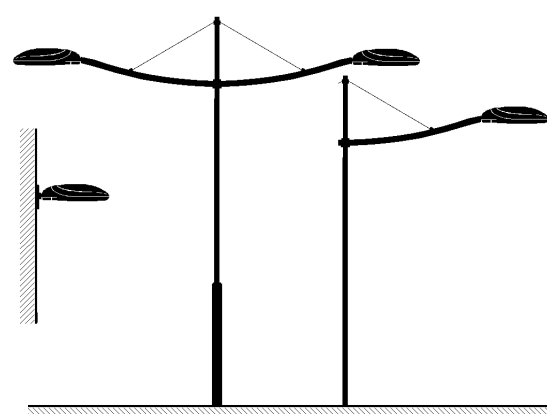
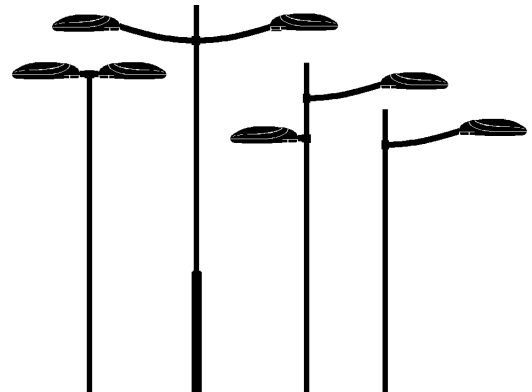

ARCHILEDE

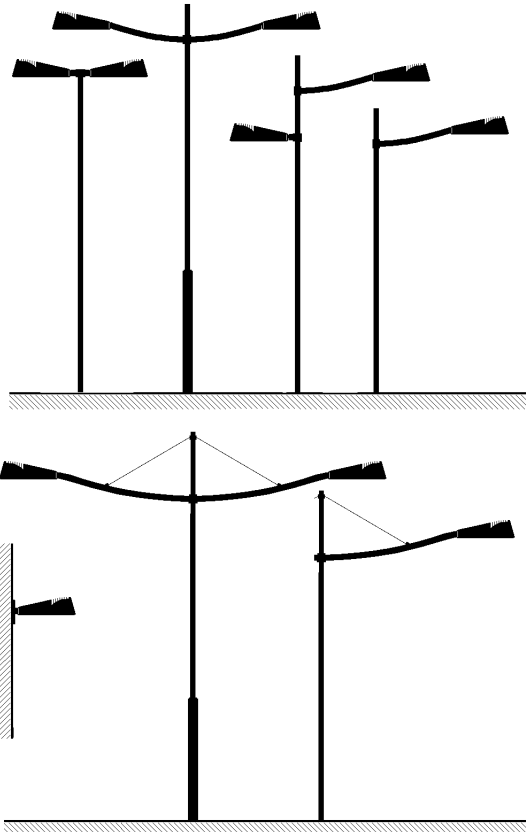

INSTALLAZIONE AD APPLIQUE CON L' ART. 6160
 WALL APPLICATION WITH ART. 6160
 INSTALLATION EN APPLIQUE AVEC L' ART. 6160
 WANDINSTALLATION MIT DEM ART. 6160
 INSTALLATIE ALS WANDARMATUUR MET ART. 6160
 INSTALACIÓN EN PARED CON ART. 6160
 VÆGMONTERING MED ART. 6160
 VEGGAPPLIKASJON MED ART. 6160
 LAMPETTINSTALLATION MED ART. 6160
МОНТАЖ БРА С ИЗДЕЛИЕМ ART. 6160 壁式

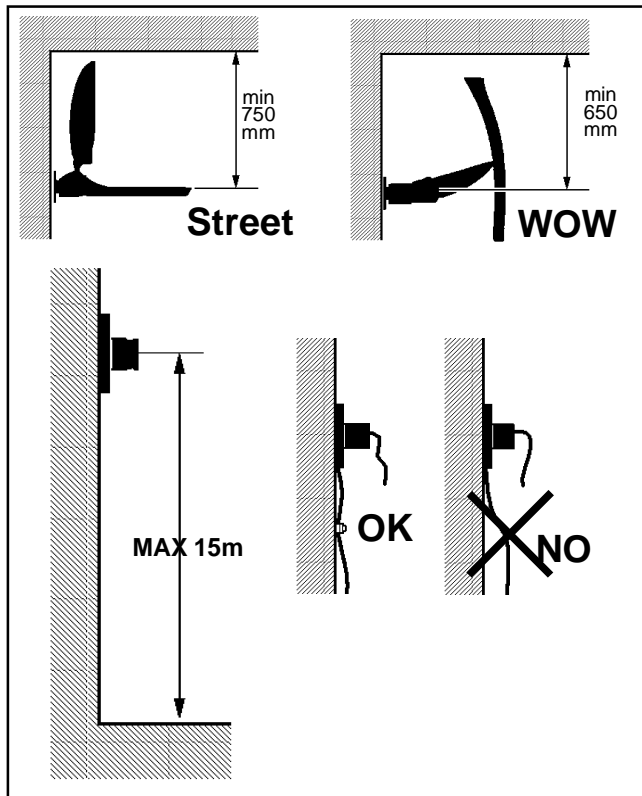

I Evitare che il peso del cavo o sue trazioni accidentali gravino sul prodotto.
N.B.: *Non sottoporre a trazioni superiori agli 80 N.
GB The cable weighing on the product or being accidentally tugged may cause damage to the product. Avoid both.
N.B.: *Do not subject to tugs greater than 80 N.
F Evitez que le poids du câble ou ses tractions accidentelles grèvent sur le produit.
N.B.: *Ne pas soumettre à des tractions dépassant 80 N.
D Achten Sie darauf, dass das Gewicht des Kabels oder eventuell auf dieses einwirkende, plötzliche Zugkräfte die Leuchte nicht belasten.
N.B.: *Vermeiden Sie eine Zugkraft von über 80 N.
NL Vermijd dat het gewicht van de kabels of accidentele tracties het product belasten.
N.B.: *Onderwerp ze niet aan een tractie die hoger is dan 80 N.
E Evitar cargar el peso del cable o sus tracciones accidentales sobre el producto.
NOTA: *No someter a tracciones superiores a 80 N.
DK Undgå, at produktet belastes af vægten fra ledningen eller utilsigtede trækpåvirkninger.
N.B.: *Forbindelsen må ikke udsættes for trækpåvirkninger på over 80 N.
N Kabelvægt på produktet eller ved å bli utilsikket strukket kan forårsake skade på produktet. Unngå begge.
N.B.: *Ikke utsett for drakrefter som er større enn 80 N.
S Undvik att kabelns vikt eller dess dragspänning sliter på utrustningen.
OBS! *Utsätt dem inte för dragkrafter över 80 N.
RUS Избегайте, чтобы вес кабеля или его случайного натяжение оказывали нагрузку на прибор.
ПРИМЕЧАНИЕ: *Не подвергать натяжению с усилием более 80 Н.
CN 电缆压在产品上或偶然拖拉可能会导致产品损坏。皆应避免。
 注意: *请勿使其受大于80N的拖曳力。

PER IL FISSAGGIO USARE TASSELLI AD ESPANSIONE CON VITI M8; IL TIPO DI TASSELLO DA USARE (NYLON, ACCIAIO, A REAZIONE CHIMICA ...) E' DA SCEGLIERE IN FUNZIONE DELLE CARATTERISTICHE DEL MATERIALE DI SUPPORTO (MURATURA, CALCESTRUZZO, METALLO ...) SU CUI VIENE APPLICATO IL PRODOTTO.
FOR ATTACHMENT, USE EXPANSION PLUGS WITH M8 SCREW; CHOOSE THE TYPE OF PLUG (NYLON, STEEL, CHEMICAL REACTION ...) ACCORDING TO THE CHARACTERISTICS OF THE SURFACE (MASONRY, CONCRETE, METAL ...) TO WHICH IT IS APPLIED.
POUR LA FIXATION, UTILISEZ DES CHEVILLES A EXPANSION ET DES VIS M8, LE TYPE DE CHEVILLE DEVANT ÊTRE UTILISÉ (NYLON, ACIER, A REACTION CHIMIQUE ...) DOIT ÊTRE CHOISI EN FONCTION DES CARACTERISTIQUES DU MATERIAU DE SUPPORT (MÇONNERIE, BETON, METAL ...) DU PRODUIT.
FÜR DIE BEFESTIGUNG SPREIZDÜBEL MIT SCHRAUBE M8 VERWENDEN; DER ZU VERWENDEDE DÜBELTYP (AUS NYLON, STAHL, MIT CHEMISCHER REAKTION ...) HÄNGT VON DEN EIGENSCHAFTEN DES BEFESTIGUNGSMATERIALS (MAUERWERK, BETON, METALL ...) AN DEM DAS PRODUKT MONTIERT WIRD, AB.
VOOR HET BEVESTIGEN GEBRUIKT MEN EXPANSIEPLUGGEN MET SCHROEVEN M 8; HET TE GEBRUIKEN TYPE PLUG (NYLON, STAAL, CHEMISH REAGEREND ...) HANGT AF VAN DE KENMERKEN VAN HET MATERIAAL WAAROP HET PRODUKT WORDT AANGEBRACHT (METSELWERK, BETON, METAL ...).
PARA LA FIJACION UTILIZAR TARUGOS DE EXPANSION CON TORNILLOS M8; EL TIPO DE TARUGO QUE DEBE USARSE (NYLON, ACERO, DE REACCION QUIMICA ...) DEBERA ELEGIRSE EN FUNCION DE LAS CARACTERISTICAS DEL MATERIAL DE SOPORTE (MAMPOSTERIA, HORMIGON, METAL ...) EN EL CUAL DEBE APLICARSE EL PRODUCTO.
FOR FASTGØRELSE SKAL MAN ANVENDE RAWLPLUGS MED SKRUEØ 10. DE PLUGS, DER KAN ANVENDES (NYLON, STÅL, MED KEMISK REAKTION ...) SKAL VÆLGES UD FRA MONTERINGSFLADERNES EGENSKABER (MURVÆRK, BETON, METAL ...) HVOR PRODUKTET SKAL MONTERES.
FOR FESTE, BRUK EKSPANSJONSPUGGER MED Ø 10 SKRUE, VELG TYPE PLUGG (NYLON, STÅL, KJEMISK REAKSJON...) ETTER EGENSKAPENE PÅ OVERFLATEN (MUR, BETONG, METALL...) SOM DE ER PÅFØRT.
FÖR FASTSÄTTNINGEN SKA EXPANSJONSPUGGAR MED Ø 10 SKRUV ANVÄNDAS. TYPER AV PUGGAR (NYLON, STÅL, KEMISK REAKTION O.S.V.) SKA VÄLJAS BERÖENDE PÅ DET BÄRANDE MATERIALETS EGENSKAPER (MURVERK, BETONG, METALL O.S.V.) DÄR PRODUKTEN APPLICERAS.
Для крепления используйте расширительные вкладыши с шурупями М8; тип вкладыша (нейлон, сталь, с химической реакцией...) выбирается по характеристикам материала основания, к которому крепится изделие (кладка, бетон, металл...). К которому крепится прибор.
至于附加装置，使用带M8螺丝的膨胀塞；根据使用塞子的表面（砖石、混凝土、金属...）的特征选择塞子的类型（尼龙、钢、化学处理...）。

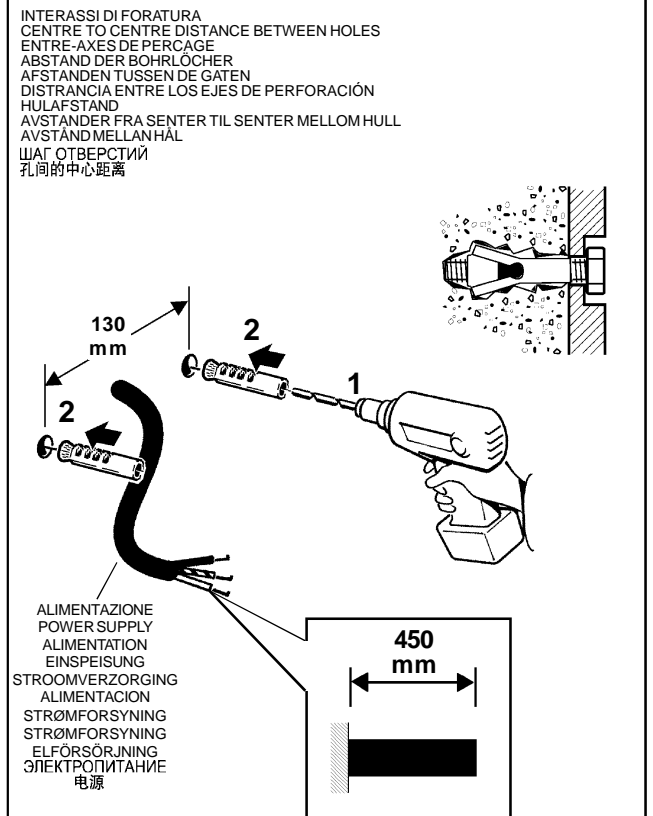

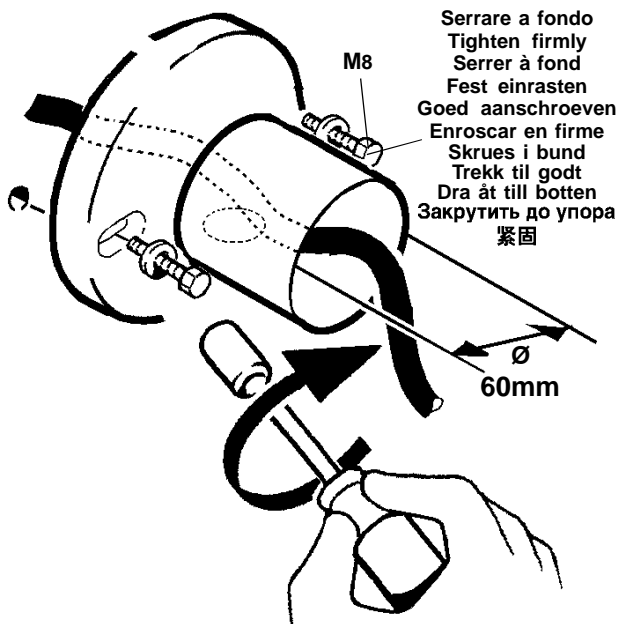

Serrare a fondo
Tighten firmly
Serrer à fond
Fest einrasten
Goed aanschroeven
Enroscar en firme
Skrues i bund
Trek til godt
Dra åt till botten
Закрутить до упора
紧固

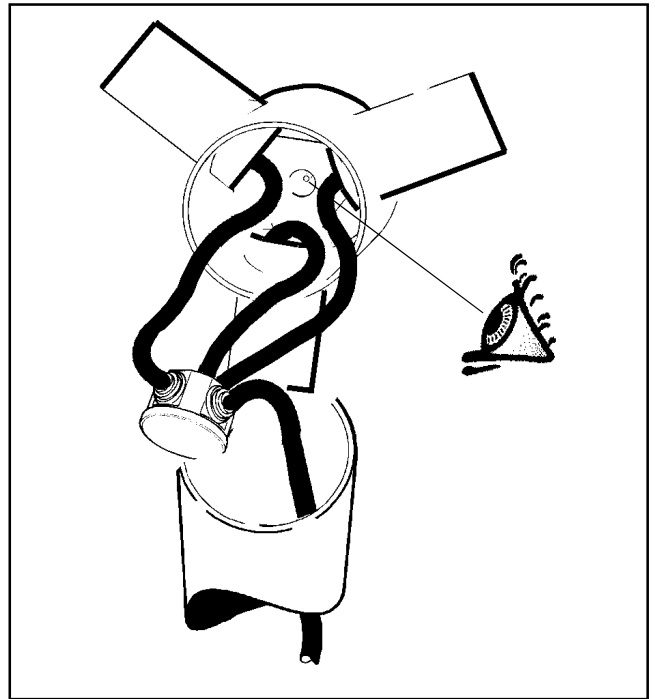
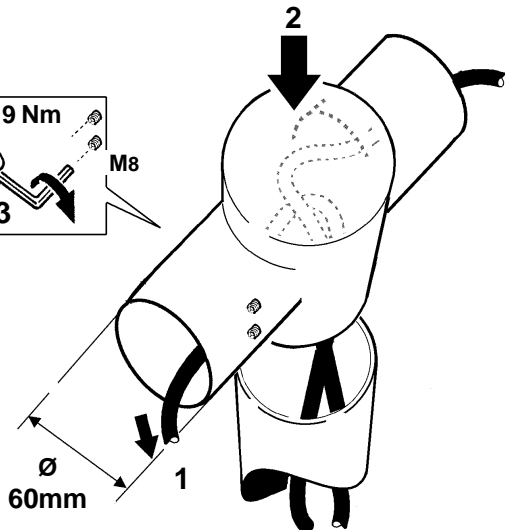
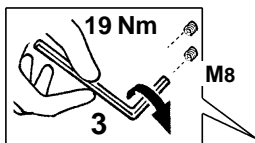
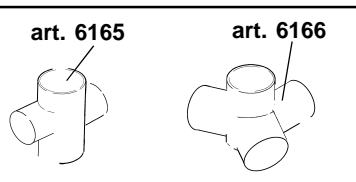
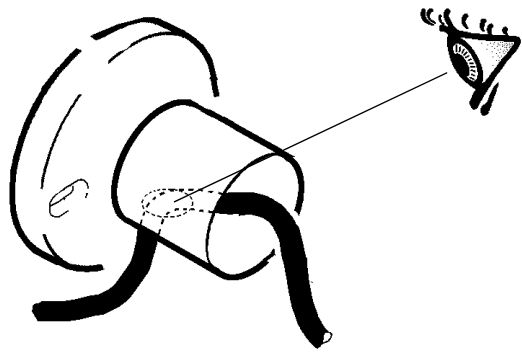

INSTALLAZIONE SU PALO CON L' ART. 6156 - 6159
POLE APPLICATION WITH ART. 6156 - 6159
INSTALLATION SUR MÂT AVEC L' ART. 6156 - 6159
MASTINSTALLATION MIT DEM ART. 6156 - 6159
INSTALLATIE OP PAAL MET ART. 6156 - 6159
INSTALACION EN POSTE CON ART. 6156 - 6159
INSTALLATION PÅ MAST MED ART. 6156 - 6159
STANGAPPLIKASJON MED ART. 6156 - 6159
INSTALLATION PÅ STOLPE MED ART. 6156 - 6159
МОНТАЖ НА ФОНАРНОМ СТОЛБЕ С АРТИКЛЕМ ART. 6156 - 6159
ART. 6156 - 6159 杆式

ART.	PALO - POLE - MAT MAST - PAAL - POSTE ФОНАРНЫЙ СТОЛБ 灯杆 Ø mm	ART.	PALO - POLE - MAT MAST - PAAL - POSTE ФОНАРНЫЙ СТОЛБ 灯杆 Ø mm
6161	102	6156	102
6162	120	6159	120

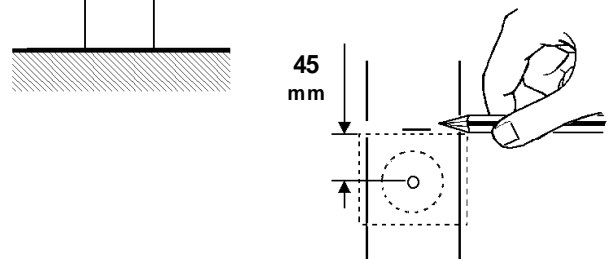
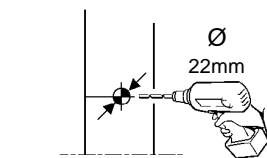
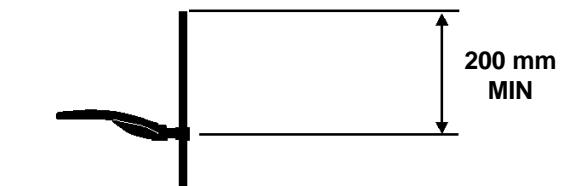

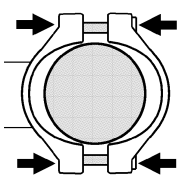
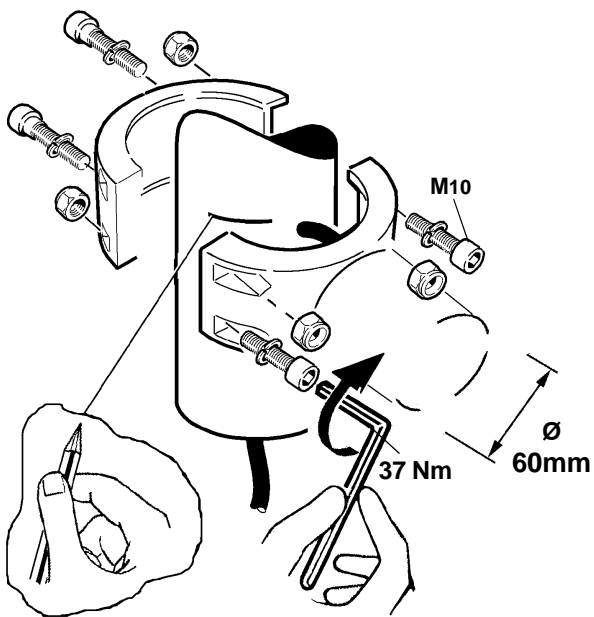
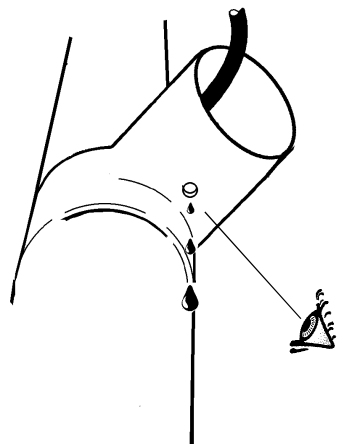
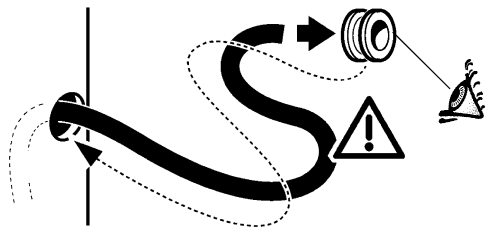

OK

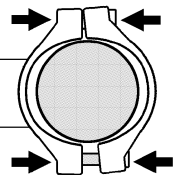

NO

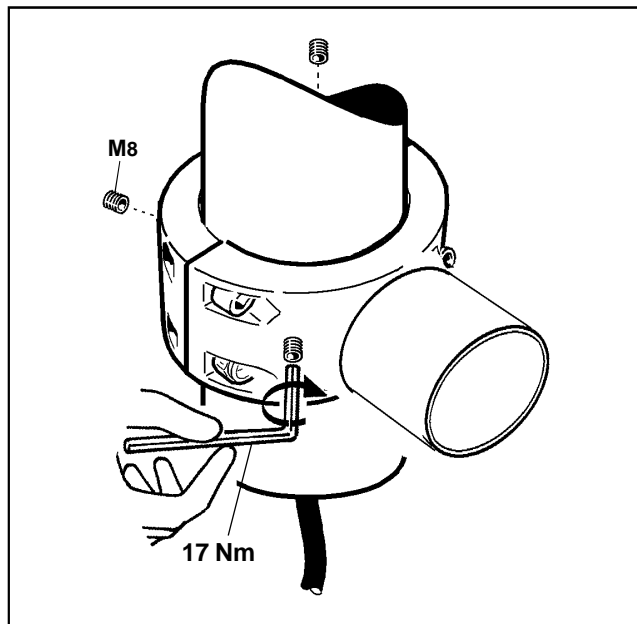

INSTALLAZIONE SU PALO CON L' ART. 6155 - 6158
 POLE APPLICATION WITH ART.6155 - 6158
 INSTALLATION SUR MÂT AVEC L' ART. 6155 - 6158
 MASTINSTALLATION MIT DEM ART. 6155 - 6158
 INSTALLATIE OP PAAL MET ART. 6155 - 6158
 INSTALACIÓN EN POSTE CON ART. 6155 - 6158
 INSTALLATION PÅ MAST MED ART. 6155 - 6158
 STANGAPPLIKASJON MED ART. 6155 - 6158
 INSTALLATION PÅ STOLPE MED ART. 6155 - 6158
 МОНТАЖ НА ФОНАРНОМ СТОЛБЕ С АРТИКЛЕМ ART. 6155 - 6158
 ART. 6155 - 6158 杆式

ART.	PALO - POLE - MAT MAST - PAAL - POSTE ФОНАРНЫЙ СТОЛБ 灯杆 Ø mm	ART.	PALO - POLE - MAT MAST - PAAL - POSTE ФОНАРНЫЙ СТОЛБ 灯杆 Ø mm
6161	102	6155	102
6162	120	6158	120

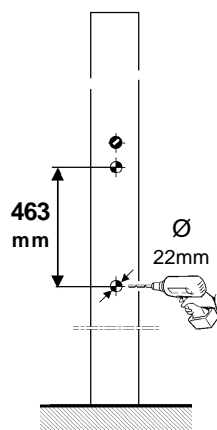
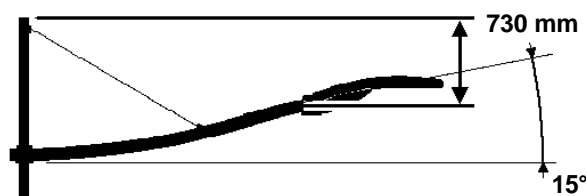

45 mm

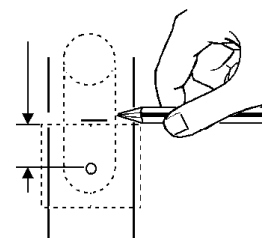

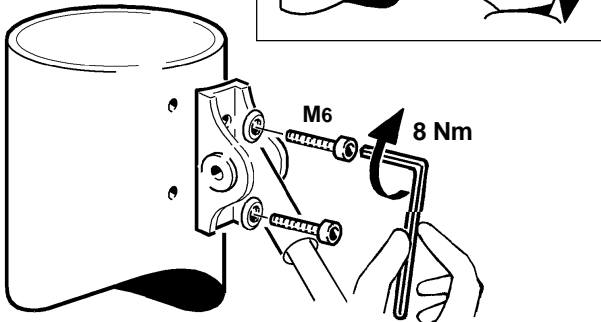
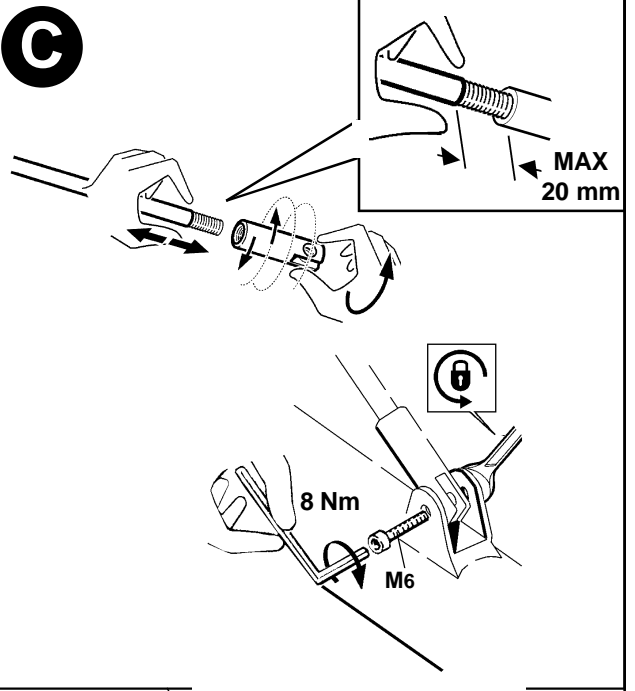
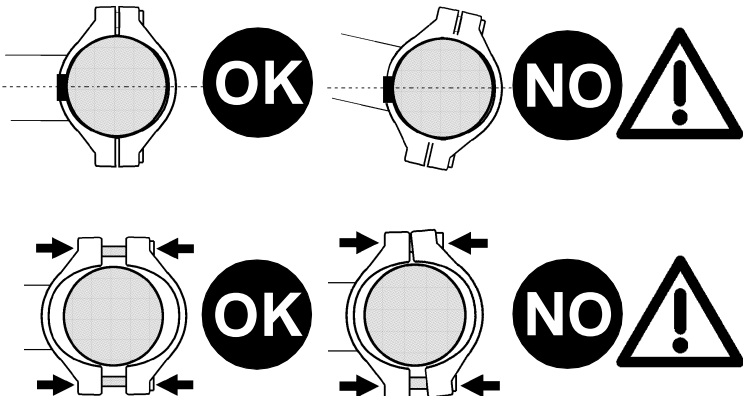
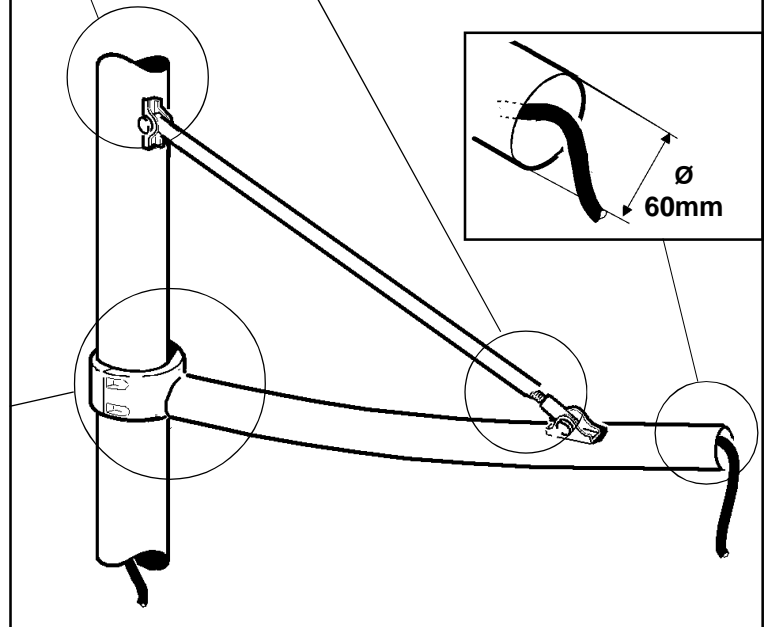
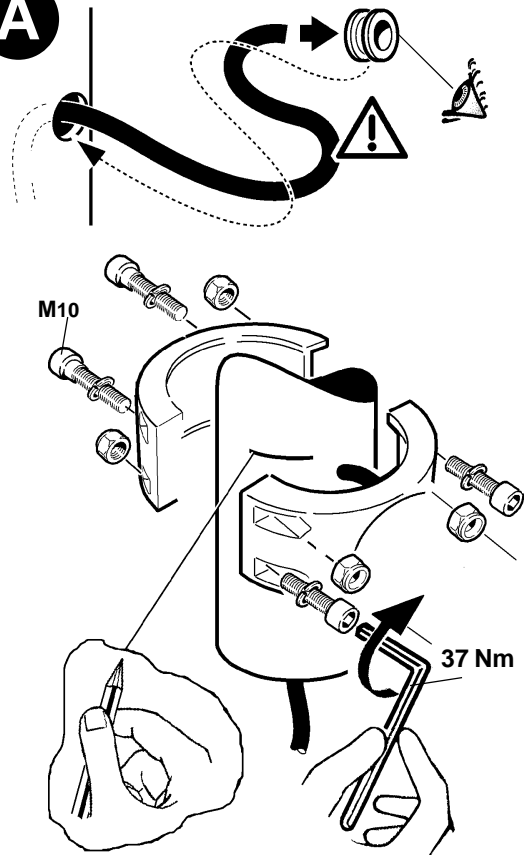
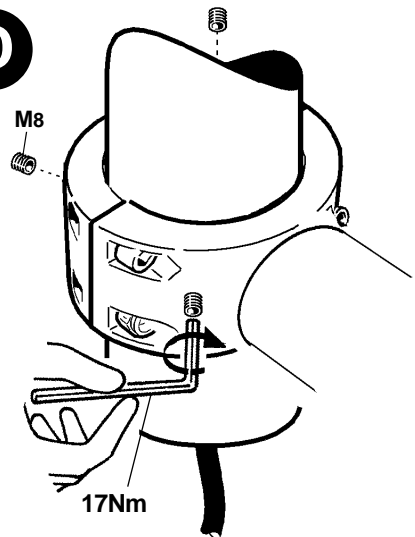
B**C****A****D**

INSTALLAZIONE SU PALO CON L' ART. 6154 - 6157
 POLE APPLICATION WITH ART. 6154 - 6157
 INSTALLATION SUR MÂT AVEC L' ART. 6154 - 6157
 MASTINSTALLATION MIT DEM ART. 6154 - 6157
 INSTALLATIE OP PAAL MET ART. 6154 - 6157
 INSTALACIÓN EN POSTE CON ART. 6154 - 6157
 INSTALLATION PÅ MAST MED ART. 6154 - 6157
 STANGAPPLIKASJON MED ART. 6154 - 6157
 INSTALLATION PÅ STOLPE MED ART. 6154 - 6157
 МОНТАЖ НА ФОНАРНОМ СТОЛБЕ С АРТИКЛЕМ ART. 6154 - 6157
 ART. 6154 - 6157 杆式

INTERASSI DI FORATURA
 CENTRE TO CENTRE DISTANCE BETWEEN HOLES
 ENTRE-AXES DE PERÇAGE
 ABSTAND DER BOHRLÖCHER
 AFSTANDEN TUSSEN DE GATEN
 DISTANCIA ENTRE LOS EJES DE PERFORACIÓN
 HULAFSTAND
 AVSTANDER FRA SENTER TIL SENTER MELLOM HULL
 AVSTÅND MELLAN HÅL
 ШАГ ОТВЕРСТИЙ
 孔间的中心距离

ART.	PALO - POLE - MÂT MAST - PAAL - POSTE ФОНАРНЫЙ СТОЛБ 灯杆
	Ø mm
6161	102
6162	120

ART.	PALO - POLE - MÂT MAST - PAAL - POSTE ФОНАРНЫЙ СТОЛБ 灯杆
	Ø mm
6154	102
6157	120

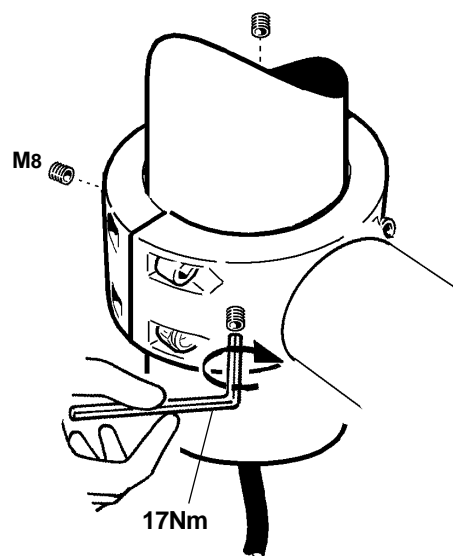
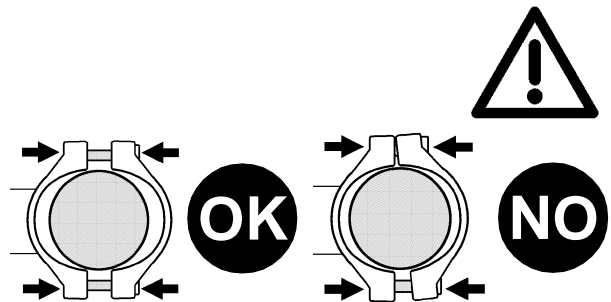
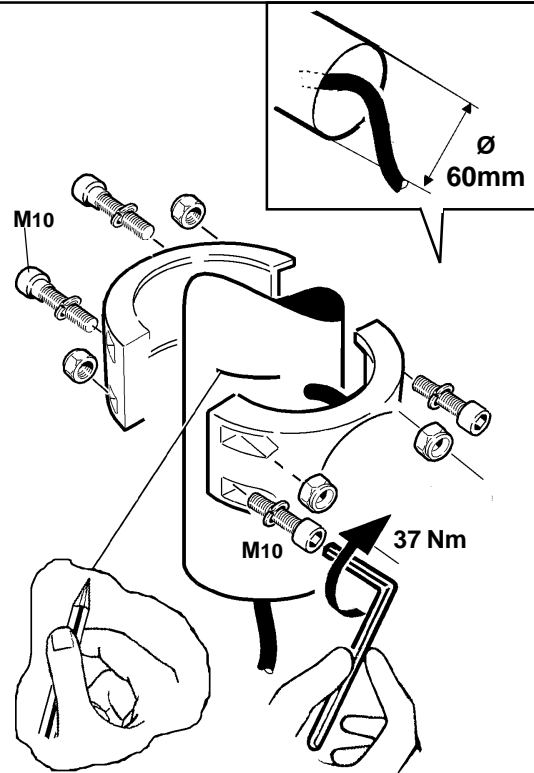
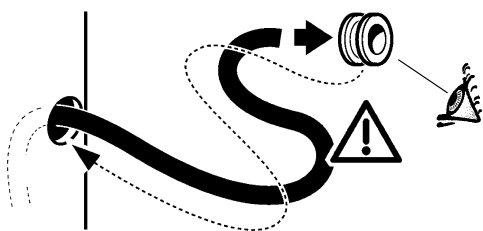
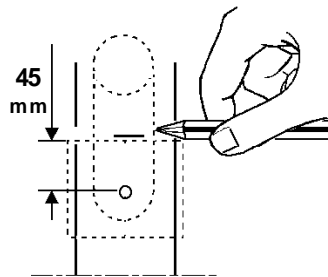
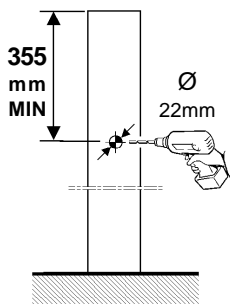
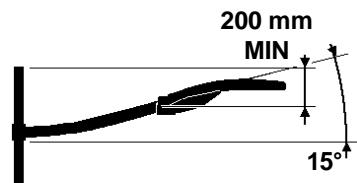

ART. 6163 - 6164

ART.	PALO - POLE - MAT MAST - PAAL - POSTE ФОНАРНЫЙ СТОЛБ 灯杆 Ø mm
6163	89
6164	114

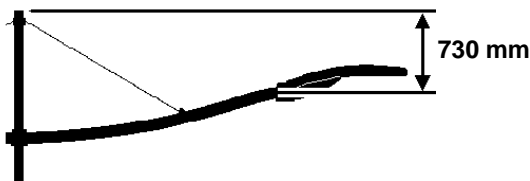
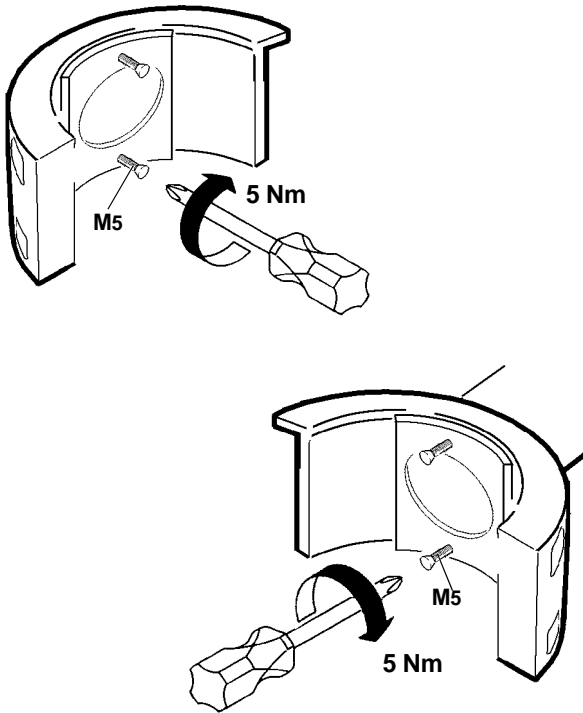

art.6163+6155

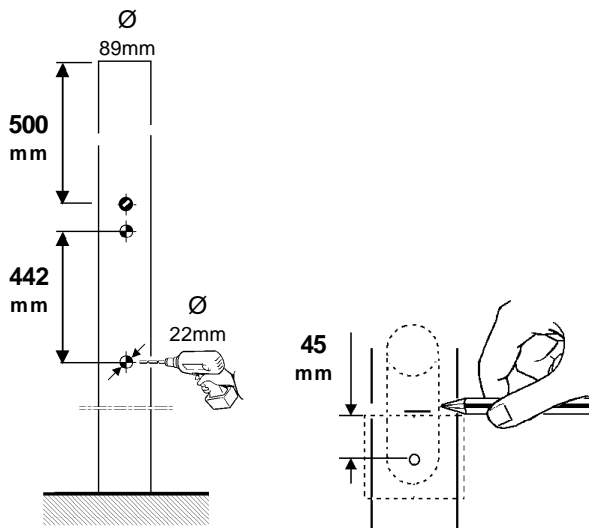

art.6164+6158

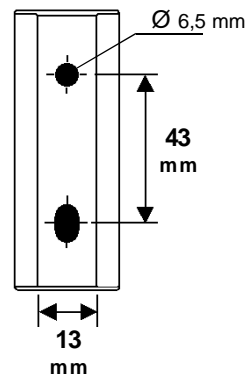
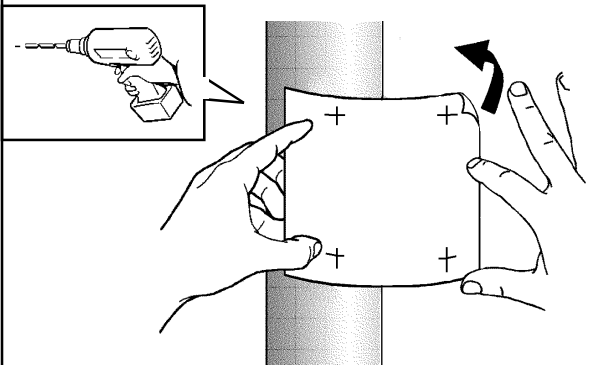
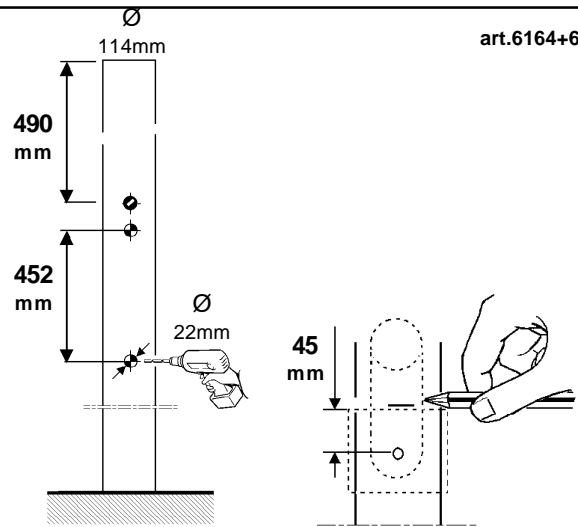

- I Per il cablaggio elettrico fare riferimento al foglio istruzioni del vano ottico.
- GB Please refer to the optical assembly instruction sheet for the electric wiring.
- F Pour le câblage électrique, se reporter à la notice d'instructions du groupe optique.
- D Informationen zur elektrischen Verkabelung können Sie den Hinweisen zum Leuchtengehäuse entnehmen.
- NL Voor de elektrische bedrading raadpleegt u het instructiebladje in het armatuur.
- E Para el cableado eléctrico hágase referencia a la hoja de instrucciones del vano óptico.
- DK Se vejledningerne til den optiske enhed for ledningsføring.
- N Vennligst se instruksjonsarket for den optiske monteringen for den elektriske kablingen.
- S Angående kabeldragningen, se instruktionsbladet för det optiska rummet.
- RUS Порядок монтажа электропроводки смотрите в инструкциях к ламповому отсеку.
- CN 针对布线，请参阅光学组件说明表。

Sistemi di installazione

تحذير :

AR لا يمكن ضمان سلامة هذا الجهاز إلا إذا التزمت بهذه التعليمات. يجب حفظها في مكان آمن.

IT ATTENZIONE:

LA SICUREZZA DELL'APPARECCHIO E' GARANTITA SOLO CON L'USO APPROPRIATO DELLE SEGUENTI ISTRUZIONI; PERTANTO E' NECESSARIO CONSERVARLE.

EN WARNING:

THE SAFETY OF THIS FIXTURE IS GUARANTEED ONLY IF YOU COMPLY WITH THESE INSTRUCTIONS; REMEMBER TO CONSERVE IN A SAFE PLACE.

ES ATENCION:

LA SEGURIDAD DEL APARATO SE GARANTIZA SOLO CUMPLIENDO CUIDADOSAMENTE LAS SIGUIENTES INSTRUCCIONES; POR ELLO, ES NECESARIO CONSERVARLAS.

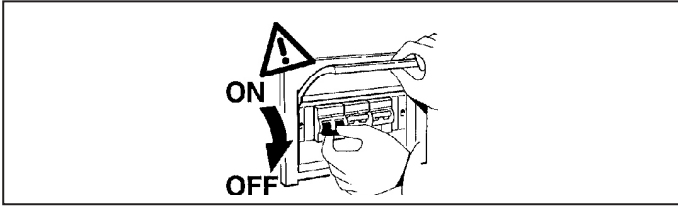

AR ملاحظة: ملاحظة: أثناء تركيب نظام . يجب التقيد بحرص بالنظم السائدة المتعلقة بالشبكة الكهربائية.

IT N.B.: DURANTE L'INSTALLAZIONE DEL SISTEMA RISPETTARE SCRUPolosAMENTE LE NORME IMPIANTISTICHE VIGENTI.

EN N.B.: WHEN INSTALLING THE SYSTEM STRICTLY COMPLY WITH ALL REGULATIONS ON INSTALLATION IN FORCE.

ES N.B.: DURANTE LA INSTALACIÓN DEL SISTEMA RESPETAR ESCRUPulosAMENTE LAS NORMAS DE INSTALACIÓN VIGENTES.

STREET

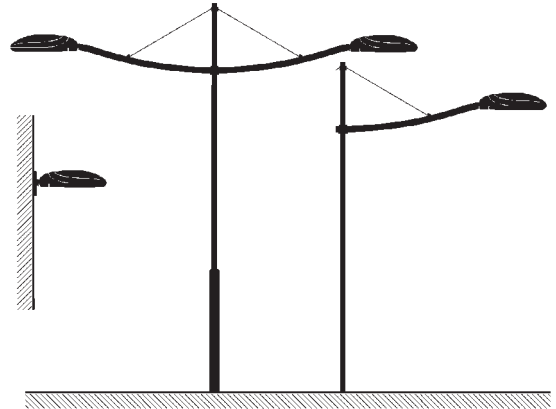
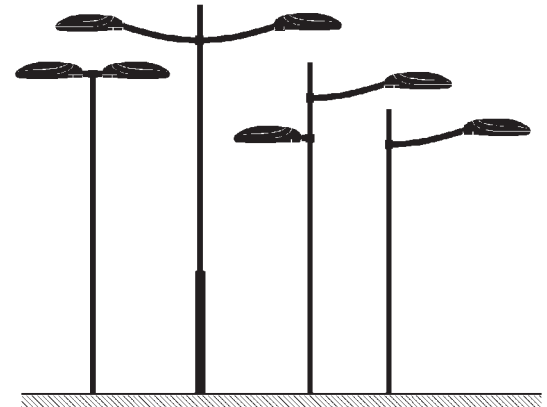

WOW

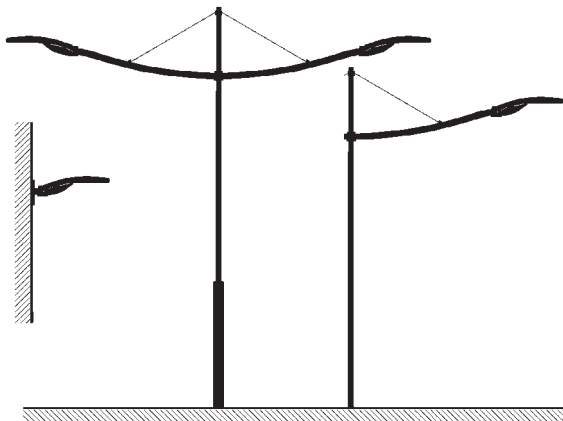
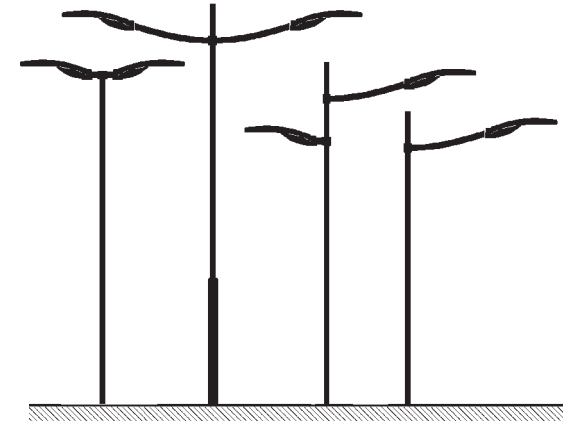

ARCHILEDE

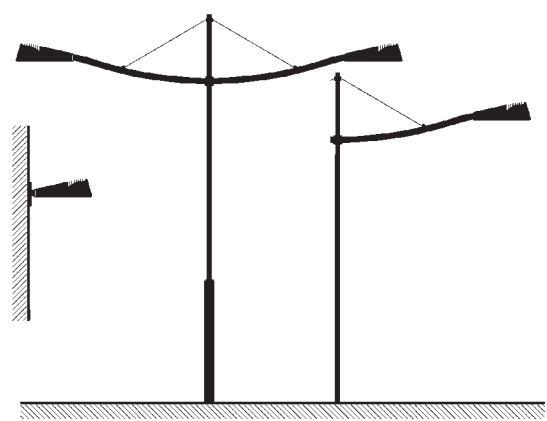
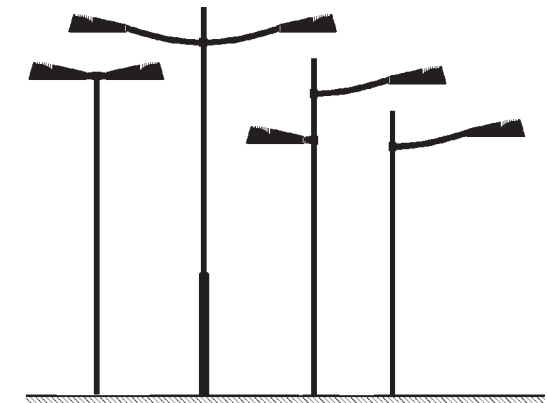

تركيب على جدار مع السلعة 6160

INSTALLAZIONE AD APPLIQUE CON L' ART. 6160
WALL APPLICATION WITH ART. 6160
INSTALACIÓN EN PARED CON ART. 6160

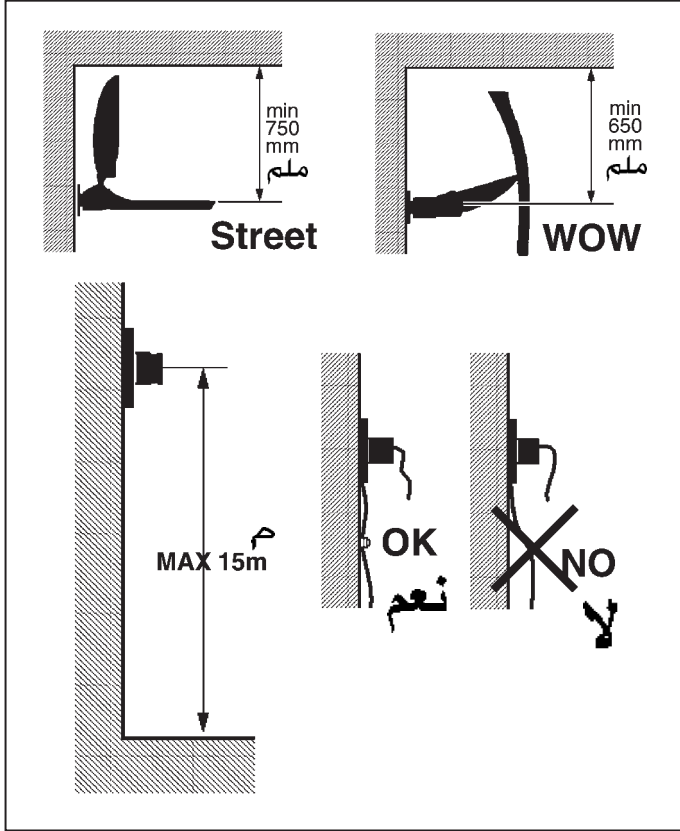

يجب مراعاة عدم تأثير وزن الكبل أو شدته بشكل عفوي على المنتج. عر
ملاحظة: * يجب عدم التفتد بقوة تزيد عن 80 نيوتن.

IT Evitare che il peso del cavo o sue trazioni accidentali gravino sul prodotto.
N.B.:*Non sottoporre a trazioni superiori agli 80 N.

EN The cable weighing on the product or being accidentally tugged may cause damage to the product. Avoid both.
N.B.:*Do not subject to tugs greater than 80 N.

ES Evitar cargar el peso del cable o sus tracciones accidentales sobre el producto.
NOTA:*No someter a tracciones superiores a 80 N.

استعمل مسامير لولبية امتدادية مع براغي M8 عند تثبيت المنتج.
ينم اختيار المسامير اللولبية المطلوب استعماله انايلون وفولاذ ويتفاعل
كيمياوي ... حسب مواصفات المادة المكون منها السطح الإستنادي (حجر،
خرسانة، معدن ...) الذي يركب عليه المنتج.

PER IL FISSAGGIO USARE TASSELLI AD ESPANSIONE CON VITI M 8; IL TIPO DI TASSELLO DA USARE (NYLON, ACCIAIO, A REAZIONE CHIMICA ...) E' DA SCEGLIERE IN FUNZIONE DELLE CARATTERISTICHE DEL MATERIALE DI SUPPORTO (MURATURA, CALCESTRUZZO, METALLO ...) SU CUI VIENE APPLICATO IL PRODOTTO.

FOR ATTACHMENT, USE EXPANSION PLUGS WITH M8 SCREW; CHOOSE THE TYPE OF PLUG (NYLON, STEEL, CHEMICAL REACTION ...) ACCORDING TO THE CHARACTERISTICS OF THE SURFACE (MASONRY, CONCRETE, METAL ...) TO WHICH IT IS APPLIED.

PARA LA FIJACION UTILIZAR TARUGOS DE EXPANSION CON TORNILLOS M 8; EL TIPO DE TARUGO QUE DEBE USARSE (NYLON, ACERO, DE REACCION QUIMICA ...) DEBERA ELEGIRSE EN FUNCION DE LAS CARACTERISTICAS DEL MATERIAL DE SOPORTE (MAMPOSTERIA, HORMIGON, METAL ...) EN EL CUAL DEBE APLICARSE EL PRODUCTO.

المسافة بين مراكز الثقوب

INTERASSI DI FORATURA
CENTRE TO CENTRE DISTANCE BETWEEN HOLES
DISTANCIA ENTRE LOS EJES DE PERFORACIÓN

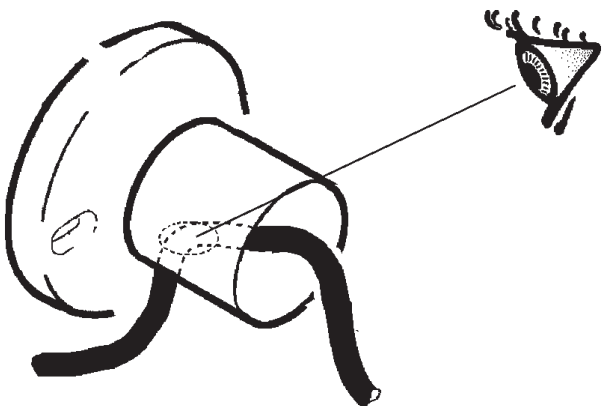
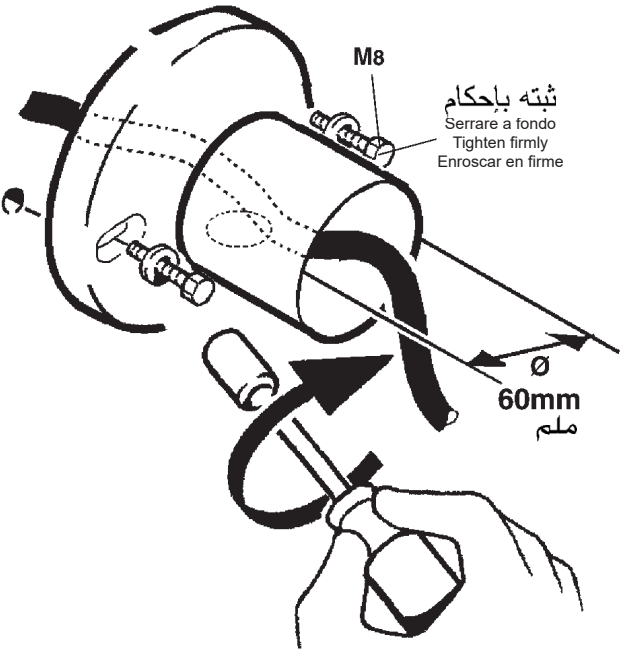
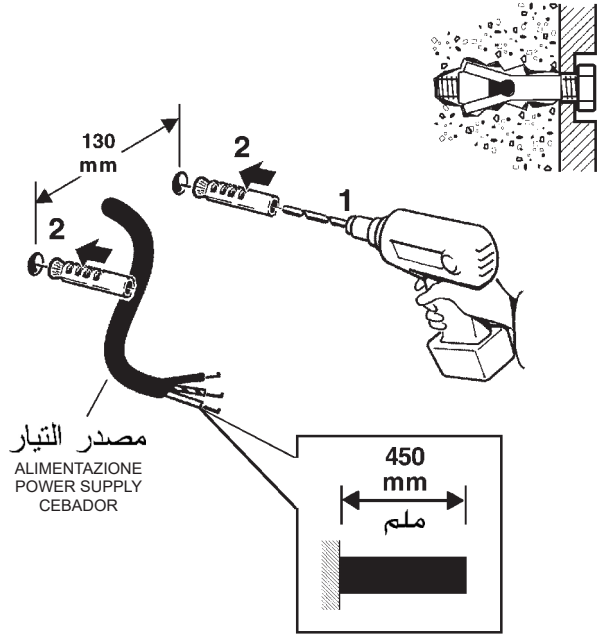

تركيب على عمود مع الساعة 6156 - 6159

INSTALLAZIONE SU PALO CON L' ART. 6156 - 6159

POLE APPLICATION WITH ART. 6156 - 6159

INSTALACIÓN EN POSTE CON ART. 6156 - 6159

ART. الصنف	عمود PALO - POLE - POSTE Ø mm ملم	ART. الصنف	عمود PALO - POLE - POSTE Ø mm ملم
6161	102	6156	102
6162	120	6159	120

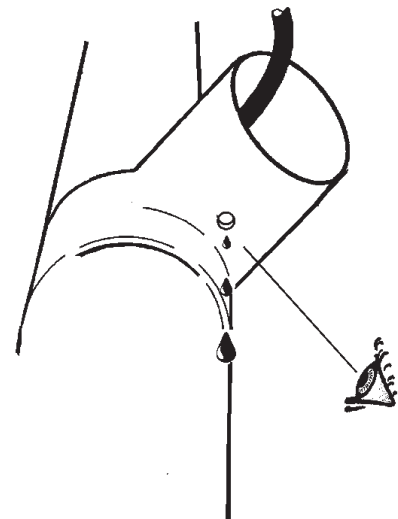
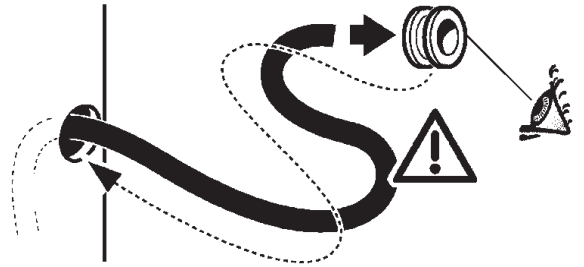
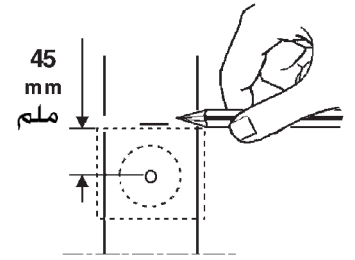
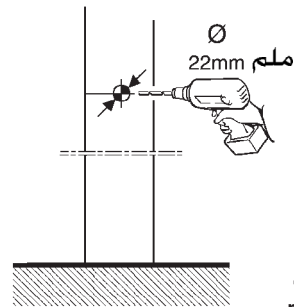
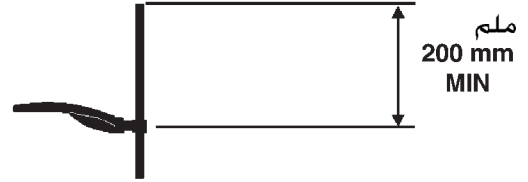
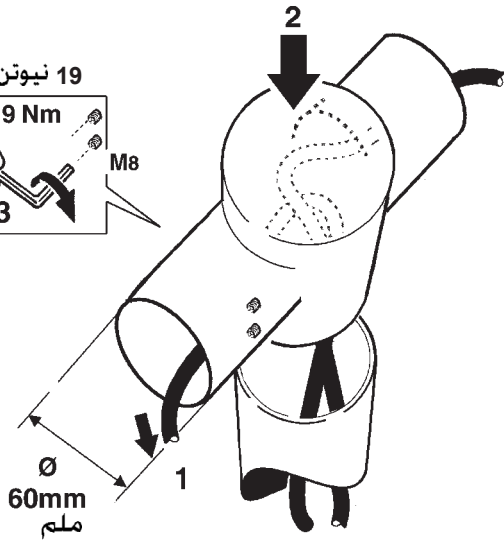
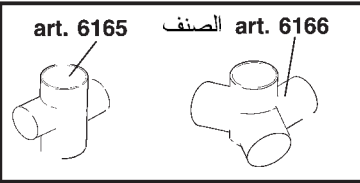

تركيب على عمود مع السلعة 6155 - 6158

INSTALLAZIONE SU PALO CON L' ART. 6155 - 6158

POLE APPLICATION WITH ART. 6155 - 6158

INSTALACIÓN EN POSTE CON ART. 6155 - 6158

ART. الصنف	عمود PALO - POLE - POSTE Ø mm ملم	ART. الصنف	عمود PALO - POLE - POSTE Ø mm ملم
6161	102	6155	102
6162	120	6158	120

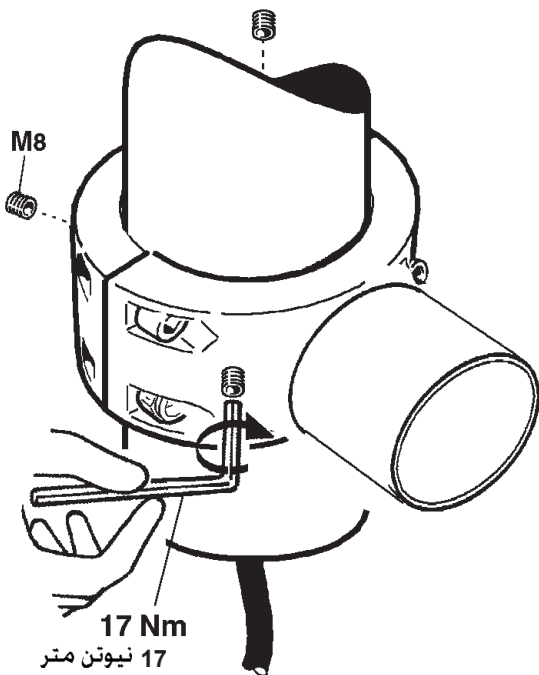
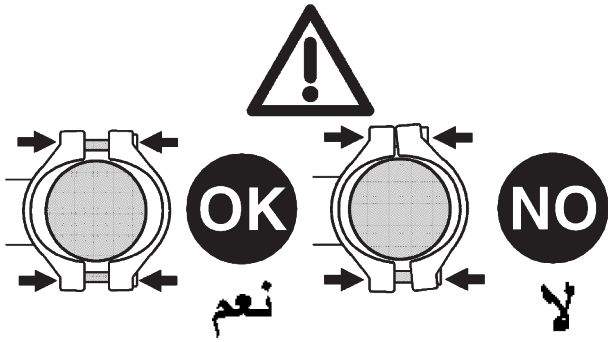
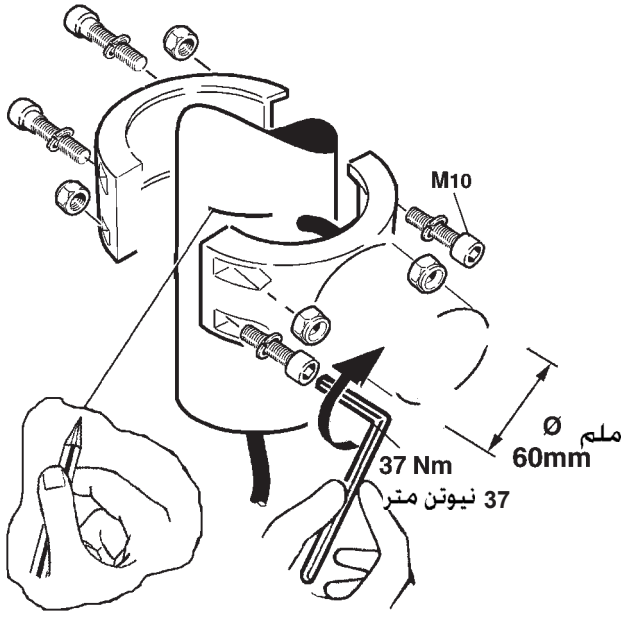
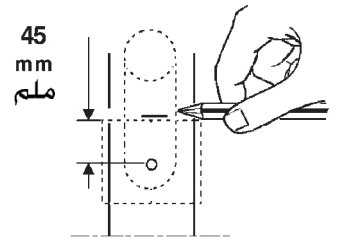
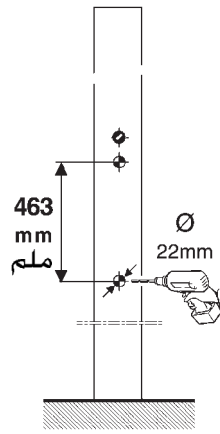
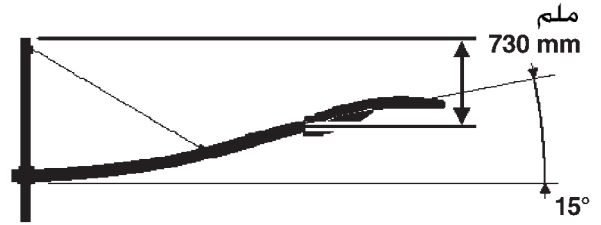

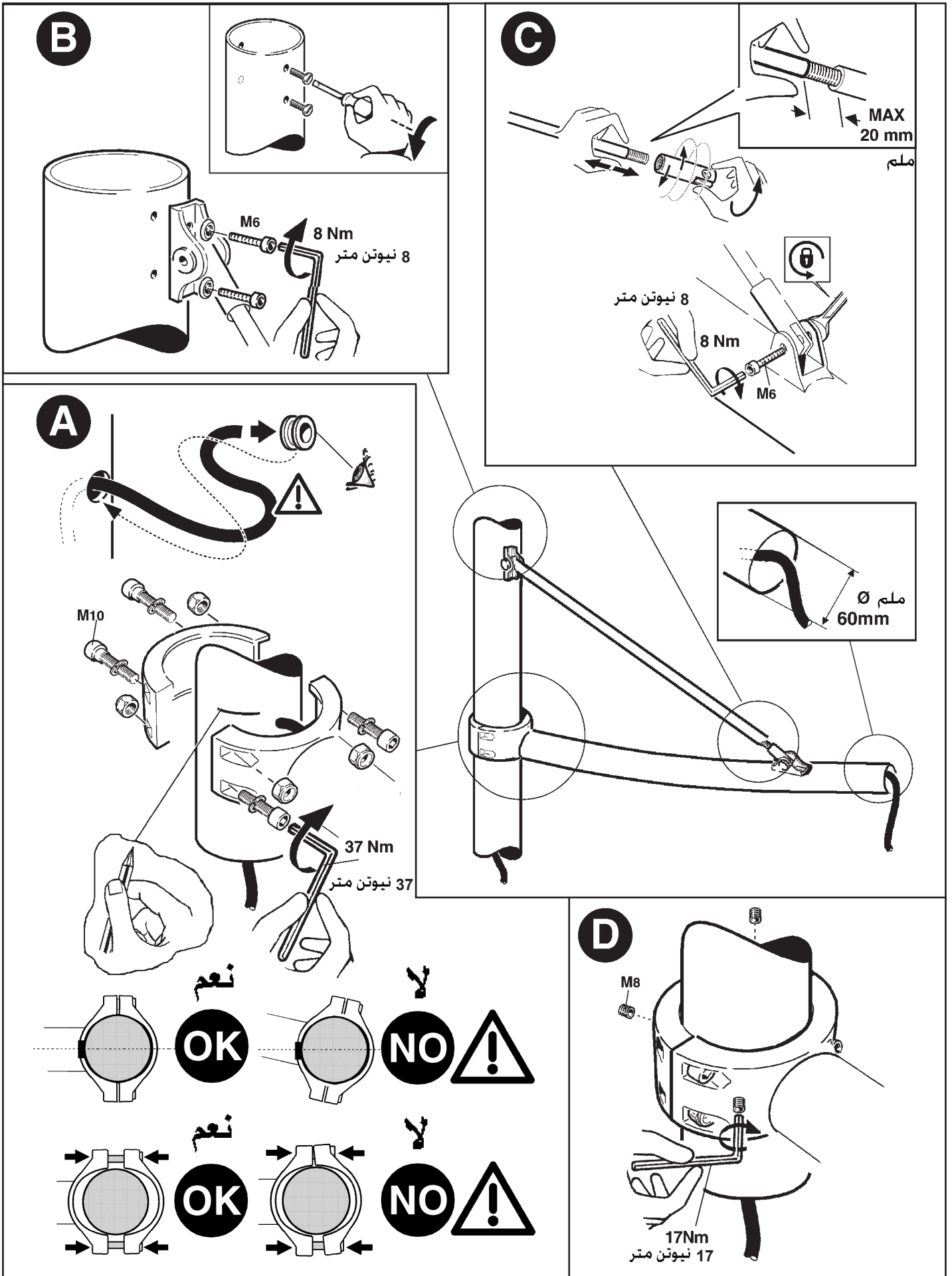

تركيب على عمود مع السلعة 6154 - 6157

INSTALLAZIONE SU PALO CON L' ART. 6154 - 6157

POLE APPLICATION WITH ART. 6154 - 6157

INSTALACIÓN EN POSTE CON ART. 6154 - 6157

المسافة بين مراكز الثقوب

INTERASSI DI FORATURA
CENTRE TO CENTRE DISTANCE BETWEEN HOLES
DISTANCIA ENTRE LOS EJES DE PERFORACIÓN

ART. الصف	عمود PALO - POLE - POSTE Ø mm ملم
6161	102
6162	120

ART. الصف	عمود PALO - POLE - POSTE Ø mm ملم
6154	102
6157	120

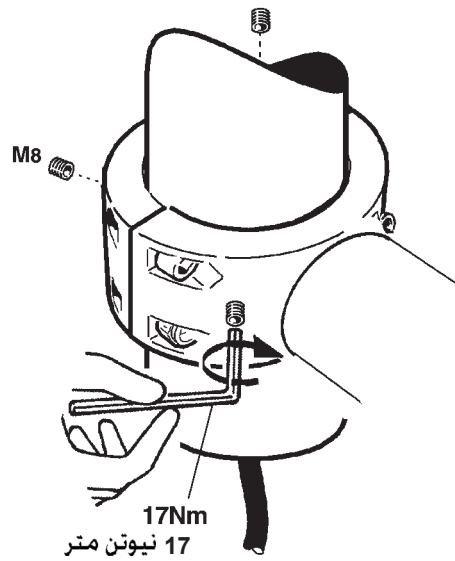
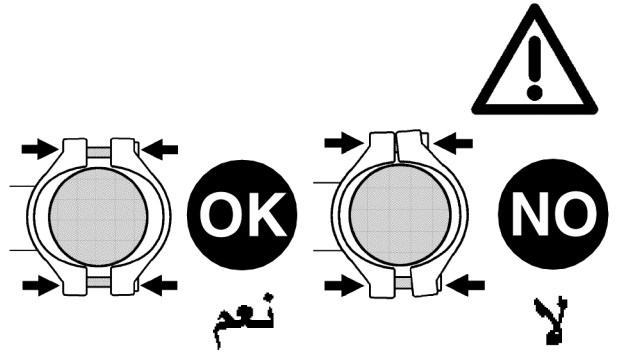
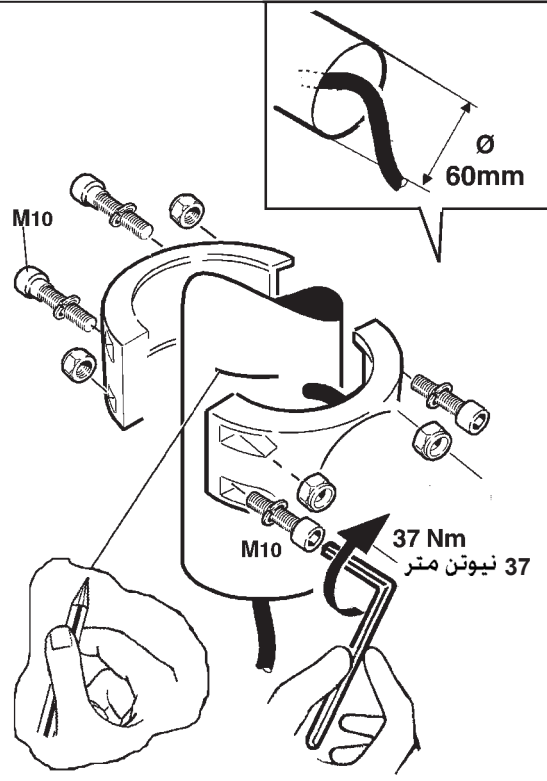
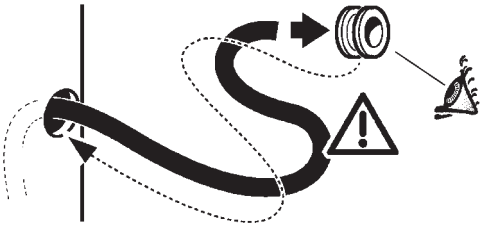
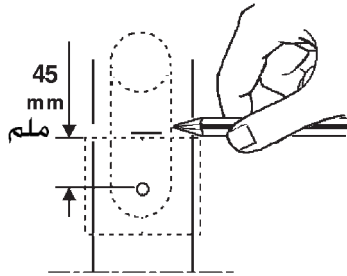
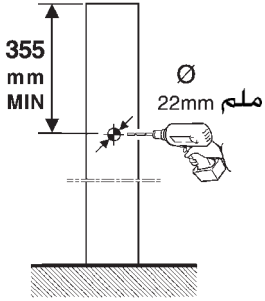
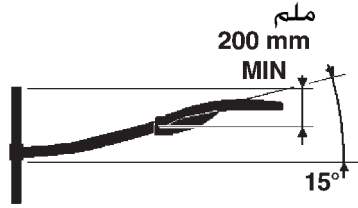

ART. 6163 - 6164

ART. الصف	عمود PALO - POLE - POSTE Ø mm ملم
6163	89
6164	114

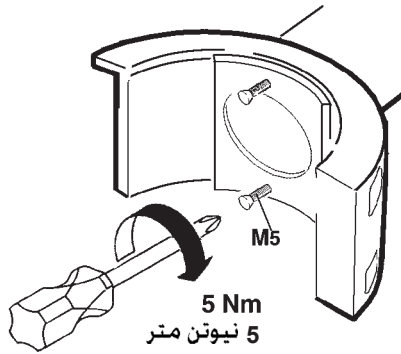
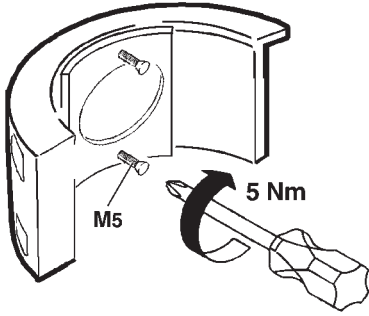

الصف art. 6163 + 6155

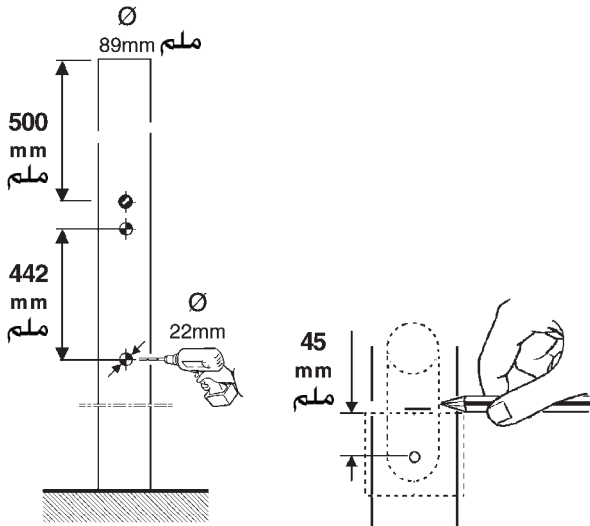

الصف art. 6164 + 6158

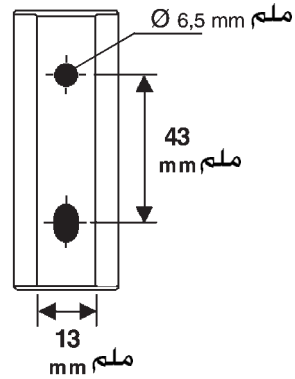
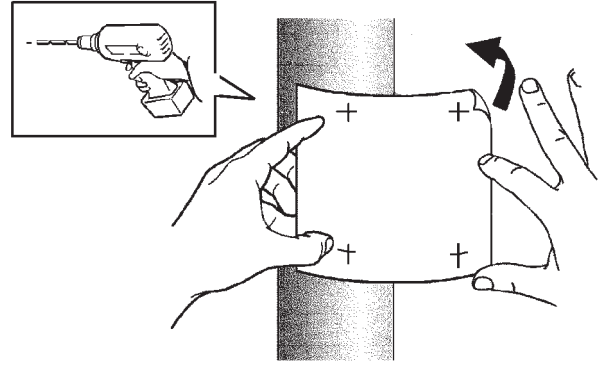
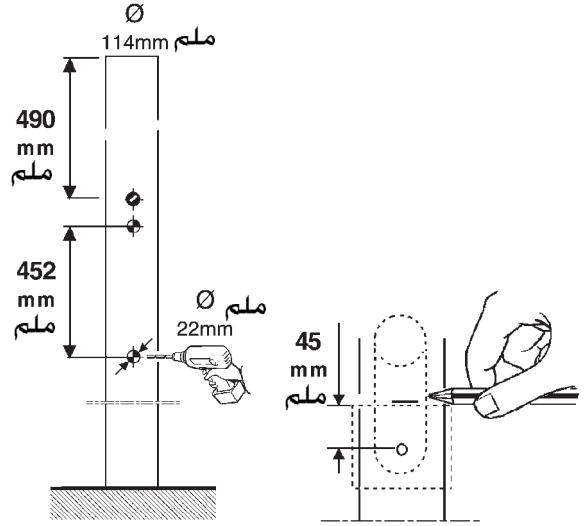

- AR بفصوص التسيابك الكهربائي، راجع ورقة التعليمات الخاصة بالحجرة البصرية.
- IT Per il cablaggio elettrico fare riferimento al foglio istruzioni del vano ottico.
- EN Please refer to the optical assembly instruction sheet for the electric wiring.
- ES Para el cableado eléctrico hágase referencia a la hoja de instrucciones del vano óptico.